



DRAFT 2023



Wheaton

STREETSCAPE STANDARDS

Abstract

The updated Wheaton Streetscape Standards illustrate improvements along public and private streets to be implemented by redeveloping properties and the Wheaton Urban District as the downtown area evolves and develops. This update was based on existing conditions analysis and stakeholder feedback and reflects current best practices for creating safe and attractive multimodal streets. Streetscape Standards are approved by the Montgomery County Planning Board to guide property owners and public entities in the preparation of development applications, and to assist the Planning Board and Planning staff during the regulatory review process. These standards can be reviewed and updated by the Planning Board as best practices and area conditions evolve over time.

Source of Copies

The Maryland-National Capital Park and Planning Commission
2425 Reedie Drive, Wheaton, MD 20902

Online at: MontgomeryPlanning.org/community/Wheaton/



Wheaton
STREETSCAPE STANDARDS

TABLE OF CONTENTS

Chapter 1 - Introduction	5
Purpose of this Update	5
Chapter 2 - Existing Conditions	13
Key Issues	13
Existing Context	14
Chapter 3 - Streetscape Standards	23
Design Principles	23
Paving Overview	24
Materials	24
Paving Plan Goals	25
Bicycle Facilities and Bus Routes	26
Accessible Routes	27
Streetscape Standards Type 1	28
Streetscape Standards Type 2	32
Streetscape Standards Type 3	34
Installation Considerations	36
Installation Details	38
Sustainability Considerations	40
Chapter 4 - Streetscape Trees and Groundcover	43
Street Trees	43
Planting Approach	44
Tree Organization	46
Planter Types	47
Soil and Soil Volume	48
Groundcover Plantings	52
Chapter 5 - Furnishings, Lighting, and Utilities	57
Street Furnishings	57
Lighting	59
Utilities	60
Mobility Elements	62
Chapter 6 - Placemaking	65
Creative Engagement	65
Connectivity	66
Opportunities	66
Enhance Existing Public Open Space	68
Wheaton Veterans Urban Park	68
Interim Gathering Space	72
Parklets	72
Shared Streets	73
Conclusion	74





CHAPTER 1

2 HR PARKING
9AM-6PM
EXCEPT SUNDAY

NO PARKING
→

GET THE TEAM
TOGETHER
FOR A ROUND

Michelob ULTRA

Introduction

Purpose of this Update

Wheaton’s recognizable streetscape pattern was developed to introduce a consistent and unifying element to the pedestrian zones in the downtown area. Since created, the Wheaton standard has been extensively implemented in various configurations throughout the Central Business District and has become a defining visual for downtown Wheaton. Implementation along internal business streets varies depending on location, but several redeveloped properties have fully implemented the current standard showcasing its full potential and demonstrating that transformative improvements to the public domain are achievable in Wheaton.

The adoption of the 2012 *Wheaton CBD and Vicinity Sector Plan* presented a comprehensive vision for the area. The 2023 *Wheaton Downtown Study* explored strategies to further the implementation of the Sector Plan, which created opportunity to update the Wheaton Streetscape Standards to ensure its guidance aligned with the redevelopment potential promoted by the sector plan’s recommendations. This update also incorporates other pavement types used by recent projects as alternatives to the original Wheaton standard, to offer variety and implementation flexibility reflective of the area’s diversity and potential for growth.

The updated streetscape standards were developed to ensure all modes and users are accommodated in a safe and attractive environment. The standards are organized by the following objectives:

- **Support redevelopment:** Provide guidance for public infrastructure and private development projects through a streetscape standard that is adaptable to individual project needs.

- **Improve walkability:** Create an accessible, walkable and bikeable urban environment supportive of existing businesses, neighborhoods, and future development.
- **Improve multimodal safety:** Build on recent plans and policies that promote enhanced bus transit, expanded bicycle networks, safer pedestrian facilities, zero fatalities and serious injuries on roadways, and environmentally sustainable practices.
- **Enhance character:** Enhance the identity of downtown Wheaton through targeted improvements and creative placemaking.



Examples of streetscape alternatives in downtown Wheaton.



Summary of Updates

The Wheaton Streetscape Standards have been updated to provide flexibility and simplify implementation. These standards incorporate recommendations for paving materials and furnishings used today throughout the downtown area, and recommend tree species and plantings to enhance the character of the area's streets. Streetscape Standards are updated to achieve the following:

1. Reduce the number of streetscape types to provide three adaptable types:
 - **Streetscape Type 1:** Precast concrete paver standard, widely used throughout downtown Wheaton over the past two decades, to be applied in the commercial areas outside the Central Triangle.
 - **Streetscape Type 2:** Clay brick pavers, which have been used in limited areas downtown, to be applied within the Central Triangle area only.
 - **Streetscape Type 3:** Poured-in-place concrete, for primarily residential streets within the Sector Plan boundary.
2. Introduce clear sidewalk zones, including a sidewalk buffer to organize tree placement, street lighting and furnishings.
3. Recommend coordinated construction of new streetscape with recommended separated bikeway facilities.
4. Establish landscape character for trees and groundcover plantings for the three Downtown Boulevards.
5. Recommend continued use of current street furnishings and street luminaires.

How to Use the Standards

The Streetscape Standards include recommendations for paving materials, tree and groundcover plantings, street furnishings, sustainability and accessibility considerations, and recommend coordination with bicycle facilities and street utilities. As projects are developed, applicants are encouraged to review the following documents concurrently for detailed information:

Complete Streets Design Guide: Provides guidance on street types and their components, to be used while designing new streets or retrofitting existing ones.

2018 Bicycle Facility Design Toolkit: Overview of the types of bikeway facilities recommended by the 2018 *Bicycle Master Plan*. Provides guidance on the elements for each type and alternatives for implementation.

Final determination on streetscape and bikeway facility design will be coordinated with the requirements of the Montgomery County Department of Transportation and Planning Staff as part of the development review process.

Construction details included in this document are for illustrative purposes only. Applicants should develop their own based on the recommendations in these documents and industry's best practices.





Applicability

The Wheaton Streetscape Standards apply to the geographic area contained within the boundary of the 2012 *Wheaton CBD and Vicinity Sector Plan*, primarily to the streets within the designated Wheaton Central Business District (CBD), also including the segments of Georgia Avenue, Veirs Mill Road, and University Boulevard West beyond the CBD but within the sector plan boundary (see Figure 01). The standards are also applicable to several residential streets within the sector plan boundary outside the CBD, namely Elkin Street and Amherst Avenue north of the CBD, Blueridge Avenue east of the CBD to the sector plan boundary, and Kensington Boulevard between Grandview Avenue and Veirs Mill Road. The standards shall also apply to privately constructed streets within the Wheaton Westfield Mall, where implementation shall be evaluated on a case-by-case basis through the development review process.

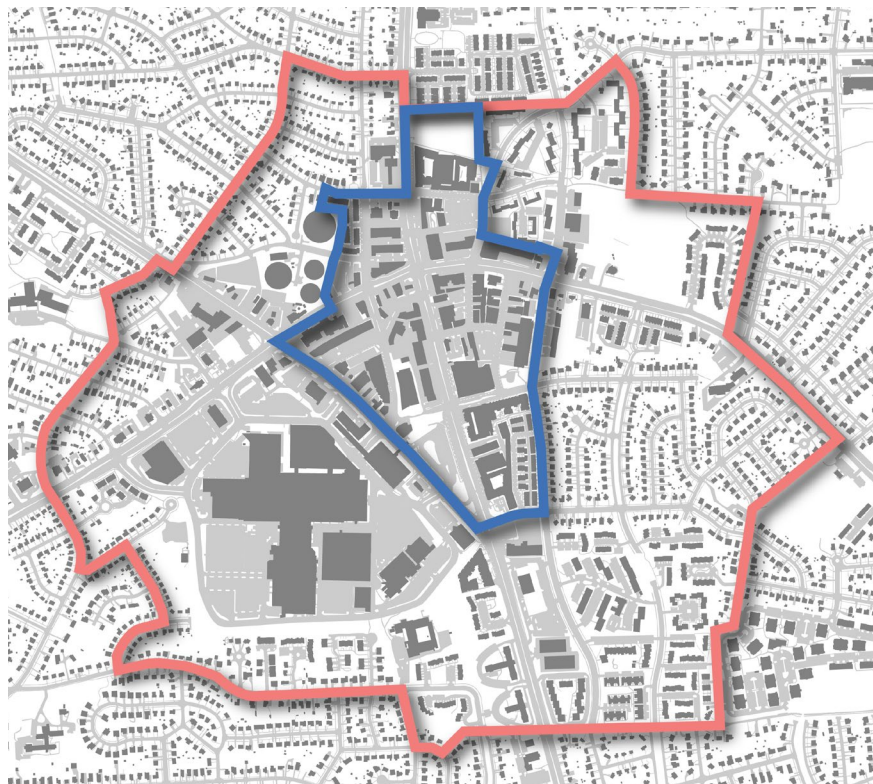

Figure 01: Wheaton Sector Plan and CBD Boundaries

Document Structure

The Wheaton Streetscape Standards include the following:

- **Introduction**
- **Existing Conditions Information**
- **Updated Streetscape Standards**
- **Placemaking Considerations**

Legend

- Sector Plan
- Central Business District





WE ARE OPEN
AS A SIGN
TAKE THIS
LAYER
MARINE

Summer
Ready!

AVERA SPA



Compatibility with Existing Plans

The updated Wheaton Streetscape Standards incorporate recommendations from the 2012 *Wheaton CBD and Vicinity Sector Plan*, the 2018 *Bicycle Master Plan*, and the 2021 *Complete Streets Design Guide* (CSDG). These standards are intended to clearly establish streetscape expectations for development applications and provide Montgomery Planning staff and the Planning Board with a framework to direct improvements to the public domain associated with future development. Specific solutions will be evaluated during the development review process based on surrounding context, site conditions, and applicable sector plan goals.

Relevant Plans, Policies, and Initiatives

This update integrates guidance from plans, policies, and initiatives with effects on downtown development quality. The following are important resources for this update:

- **2013 Countywide Transit Corridors Functional Master Plan:** Establishes a vision for a comprehensive network of transit facilities in Montgomery County.
- **2018 Bicycle Master Plan:** Sets a vision for Montgomery County as a world-class bicycling community, where people in all areas of the county have access to a comfortable, safe, and connected bicycle network.
- **Vision Zero Action Plan:** Establishes activities and projects to eliminate fatalities and serious injuries on our roads by 2030.
- **Complete Streets Design Guide:** A one-stop guide for designing new streets and reconstructing or retrofitting existing streets following safety, sustainability, and vitality principles.
- **Pedestrian Master Plan:** A suite of recommendations to make it easier, safer and more direct to walk and roll in Montgomery County.
- **Thrive Montgomery 2050:** Montgomery County's General Plan,

a framework for future planning and development that defines the basic land use, transportation and urban design policies for all public and private development in the county.

- **Climate Action Plan:** Montgomery County's strategic plan to cut greenhouse gas (GHG) emissions 80 percent by 2027 and 100 percent by 2035.
- **Context Driven – Access & Mobility for All Users:** Maryland State Highway Administration's planning and design resource "centered on establishing safe and effective multimodal transportation systems."



CHAPTER 2

A photograph of a modern city street scene. In the foreground, a paved sidewalk features a wooden bench and a planter box with greenery. A person is walking on the sidewalk to the left. In the middle ground, a red car is driving on a road. The background shows more trees and buildings under a clear blue sky. A large, white, semi-transparent text overlay reading 'CHAPTER 2' is positioned diagonally across the center of the image. The image is framed by blue diagonal borders at the top-left and bottom-right corners.

Existing Conditions

Key Issues

The 2002 Wheaton Streetscape Standards have been implemented along several downtown corridors and streets, but the area still lacks a unified character given many areas remain unimproved. Significant streetscape improvements are usually part of property redevelopment, and while some properties have fully implemented the 2002 standards, these have occurred in isolated instances resulting in an uneven downtown environment.

Opportunities

This update builds upon the recommendations of the 2012 *Wheaton CBD and Vicinity Sector Plan*, and on community engagement completed for the 2023 *Wheaton Downtown Study* and this update to the Streetscape Standards. Outreach with local stakeholders identified opportunities for a diverse and eclectic public realm by focusing on integrating the following:

- **Future Development:** Redevelopment of key properties offers significant opportunity to improve the public realm at strategic locations and improve connectivity between neighborhoods.
- **Paving Materials:** Different paving materials to the 2002 standard exist in Wheaton, creating the opportunity to consider alternative paving mixes to reflect the diverse character of the area.
- **Mobility Alternatives:** Improved pedestrian environments should safely accommodate walking, bicycling, other forms of micromobility and transit services.
- **Street Trees:** Limited existing tree canopy should expand as the public realm is improved, to provide comfort and contribute to establish distinctive district character.



Examples of various existing sidewalk conditions in downtown Wheaton.



Existing Context

This chapter describes the implementation context for this update, which must consider areas already improved following the 2002 Streetscape Standards, integrate recommendations from plans and policies adopted over the last two decades regarding mobility, safety and sustainability, and coordinate with recommendations for the expansion of existing transportation facilities.

Street Network

Wheaton's compact downtown benefits from a network of quiet residential streets, business streets, and larger state highways. The sector plan prioritizes transforming downtown highways into boulevards with wider sidewalks, trees, and additional crosswalks to improve attractiveness, safety, and pedestrian connectivity. The 2023 *Wheaton Downtown Study* goes further by recommending a hierarchy within state highways, where Georgia Avenue becomes main street, University Boulevard West slows traffic through downtown but retains its east-west connector status, and a road diet for Veirs Mill Road within downtown to improve pedestrian mobility and promote synergies between adjacent properties with development potential.

Legend

-  Streetscape Type A1
-  Streetscape Type A2
-  Streetscape Type A3
-  Streetscape Type B1
-  Streetscape Type C1
-  Unclassified Streetscape
-  Building Footprint

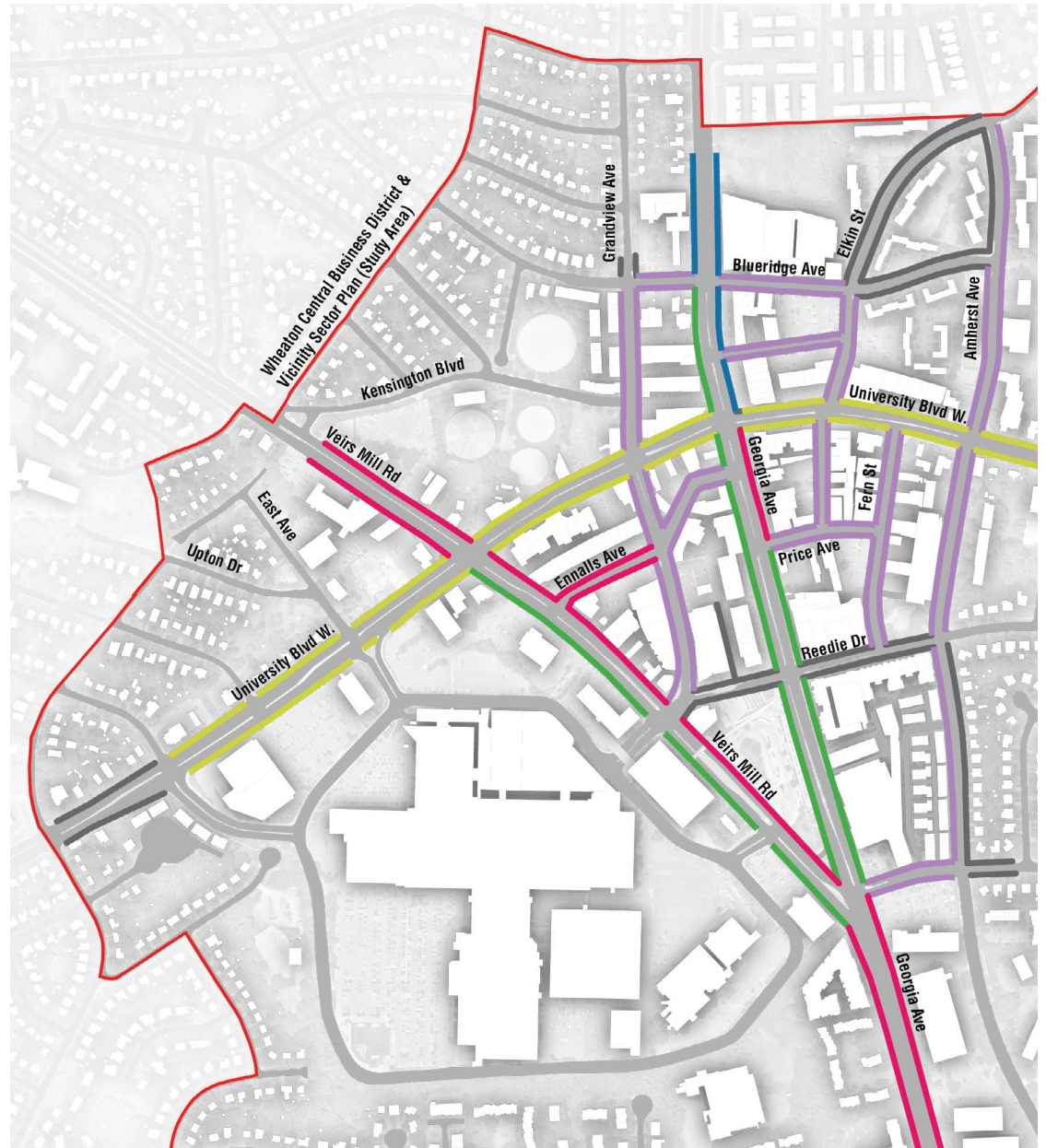
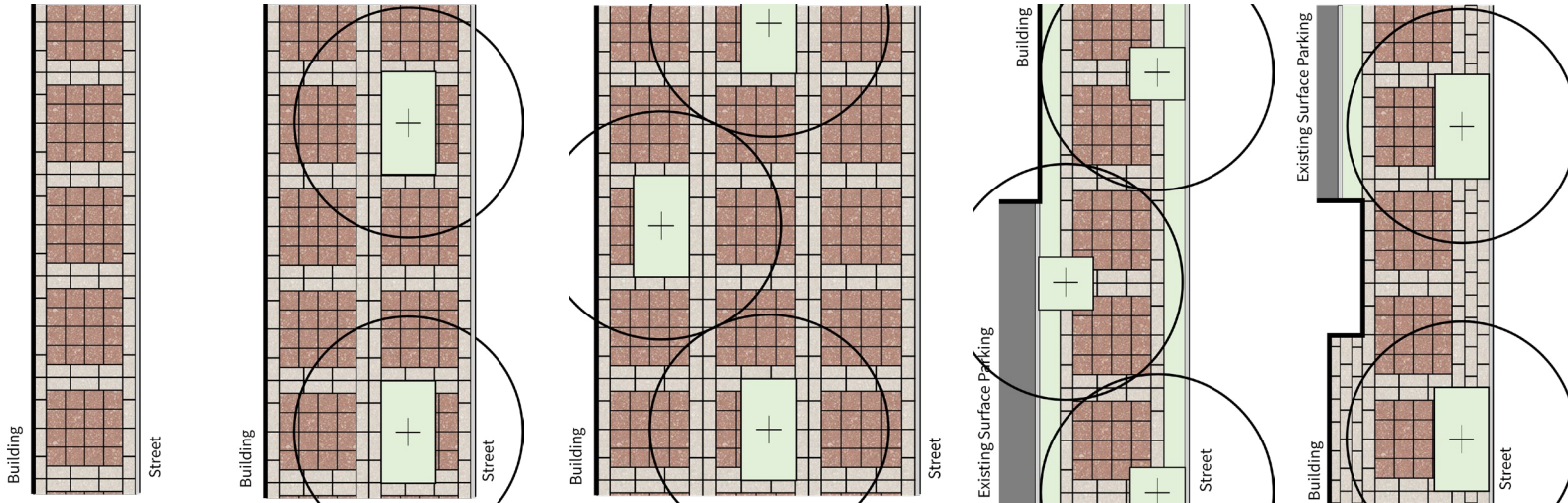

Figure 02: Recommended streetscape types per 2002 Wheaton Streetscape Standards





Type A1

Single Wheaton Paving module; no tree planting pit

Type A2

Double Wheaton Paving module; single row tree planting pits within curbside modules

Type A3

Triple Wheaton Paving module; staggered rows of tree planting pits within building side modules

Type B1

Single Wheaton Paving module; staggered tree planting pits both sides with connecting planting beds

Type C1

Single Wheaton Paving module; single tree planting pits with filler rectangular pavers for retrofit scenarios



Wheaton Standard Paving Modules

2002 Wheaton Streetscape Standards

- 2002 types are included for coordination purposes (see Figure 02). In areas outside Wheaton’s Central Triangle (the downtown area contained within the intersection of Georgia Avenue, Veirs Mill Road, and University Boulevard West), these pavers will continue to be the recommended sidewalk paver, with the layout modifications described in the updated streetscape standards chapter.
- As properties redevelop, transitions between new streetscape installations and the 2002 types already installed will be required. Those will be evaluated on a case-by-case basis through Montgomery Planning’s development review process.



Street Classifications

The 2012 Sector Plan classified public streets as Business Streets, Primary Residential Streets, or Major Highways. Since the approval of the Sector Plan, the County Council comprehensively overhauled its street classification system, in line with the guidance in the *Complete Streets Design Guide* (CSDG). The CSDG created an adaptable approach to a safe multimodal street network by defining street types that include pedestrian, bicycle, bus, and vehicular facilities suitable for adjacent land uses and projected mobility volumes. The updated Wheaton Streetscape Standards are consistent with CSDG's approach and street types (see Figure 03). Street classifications were updated as follows (CSDG classification in **bold**):

- Major Highway: **Downtown Boulevard** (Figure 04, p. 17).
- Business Street: **Downtown Street** (Figure 05, p. 17).
- Primary Residential Streets: **Neighborhood Connector** (Figure 06, p. 17).

Legend

	Downtown Boulevard
	Downtown Street
	Neighborhood Connector
	Downtown Street (Planned)
	Local Street
	Parks / Future parks
	Building Footprint

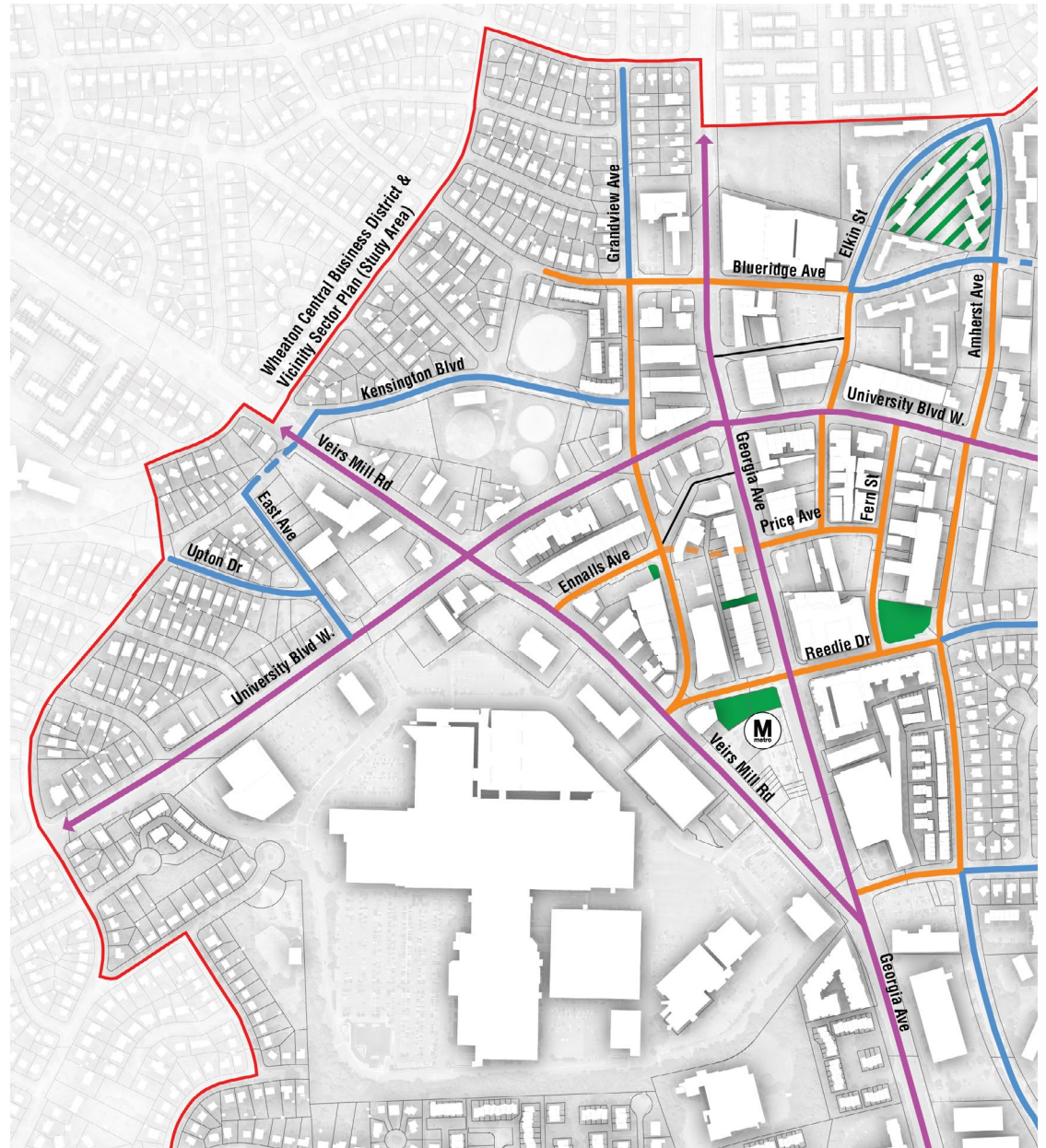

Figure 03: Street Classifications per the Complete Streets Design Guide



Street Types

Section diagrams from the CSDG are included to facilitate coordination with street improvements as redevelopment at various locations moves forward. Diagrams are prototypical; extent of actual improvements at any given location will be reviewed on a case-by-case basis, in coordination with applicable master or sector plan recommendations through the development review process.

- | | | |
|----------------------------------|--------------------------|------------------------------|
| FZ Frontage Zone | SB Street Buffer | MB Maintenance Buffer |
| SW Sidewalk | TV Travel Lane | SP Sidepath |
| PB Pedestrian-Bike Buffer | TL Transit Lane | P Parking Lane |
| BL Bike Lane | TB Transit Buffer | |

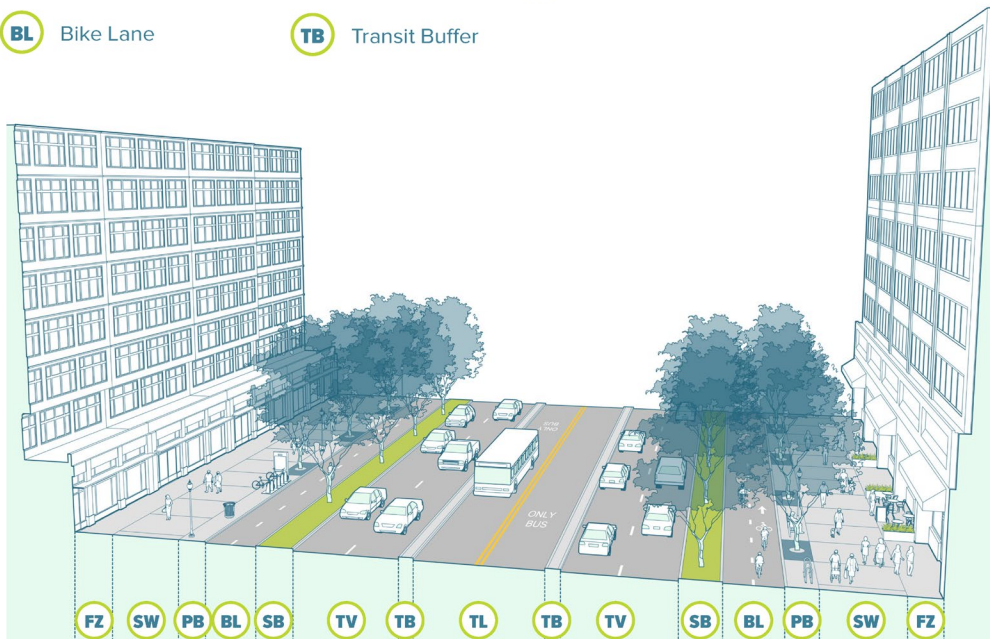

Figure 04: Downtown Boulevard (from CSDG)

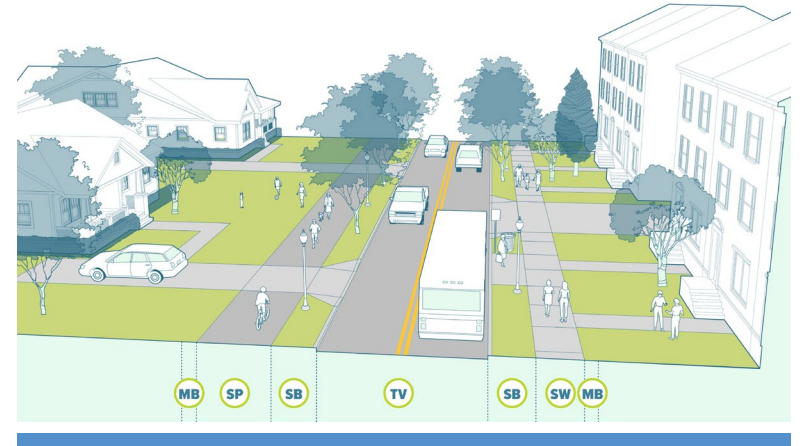

Figure 06: Neighborhood Connector (from CSDG)

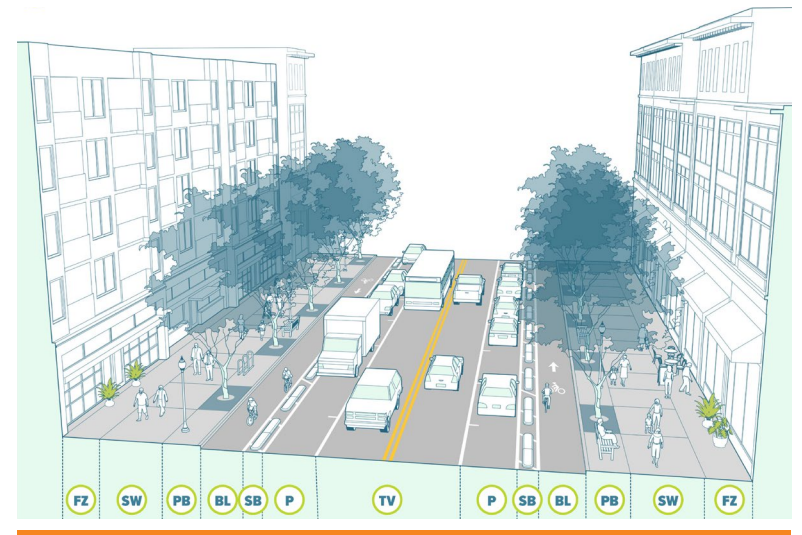

Figure 05: Downtown Street (from CSDG)



Transportation Network

Streetscape improvements should coordinate with the recommendations included in the 2013 *Countywide Transit Corridors Functional Master Plan* and the 2018 *Bicycle Master Plan* (see Figure 07). Two BRT lines are planned through downtown Wheaton that would converge at the Wheaton Metro Station, along several bicycle routes. Recommended streetscape types must be designed and constructed to accommodate elements of these transportation systems, such as:

- Bus stops
- Separated bicycle facilities integrated into streetscape construction
- Bikeshare stations
- Bicycle parking areas
- Space for parking and utilizing dockless micromobility alternatives

Alternatives included in the 2023 *Wheaton Downtown Study* for the segment of Veirs Mill Road between University Boulevard West and Georgia Avenue should be explored if WMATA or Westfield properties redevelop.

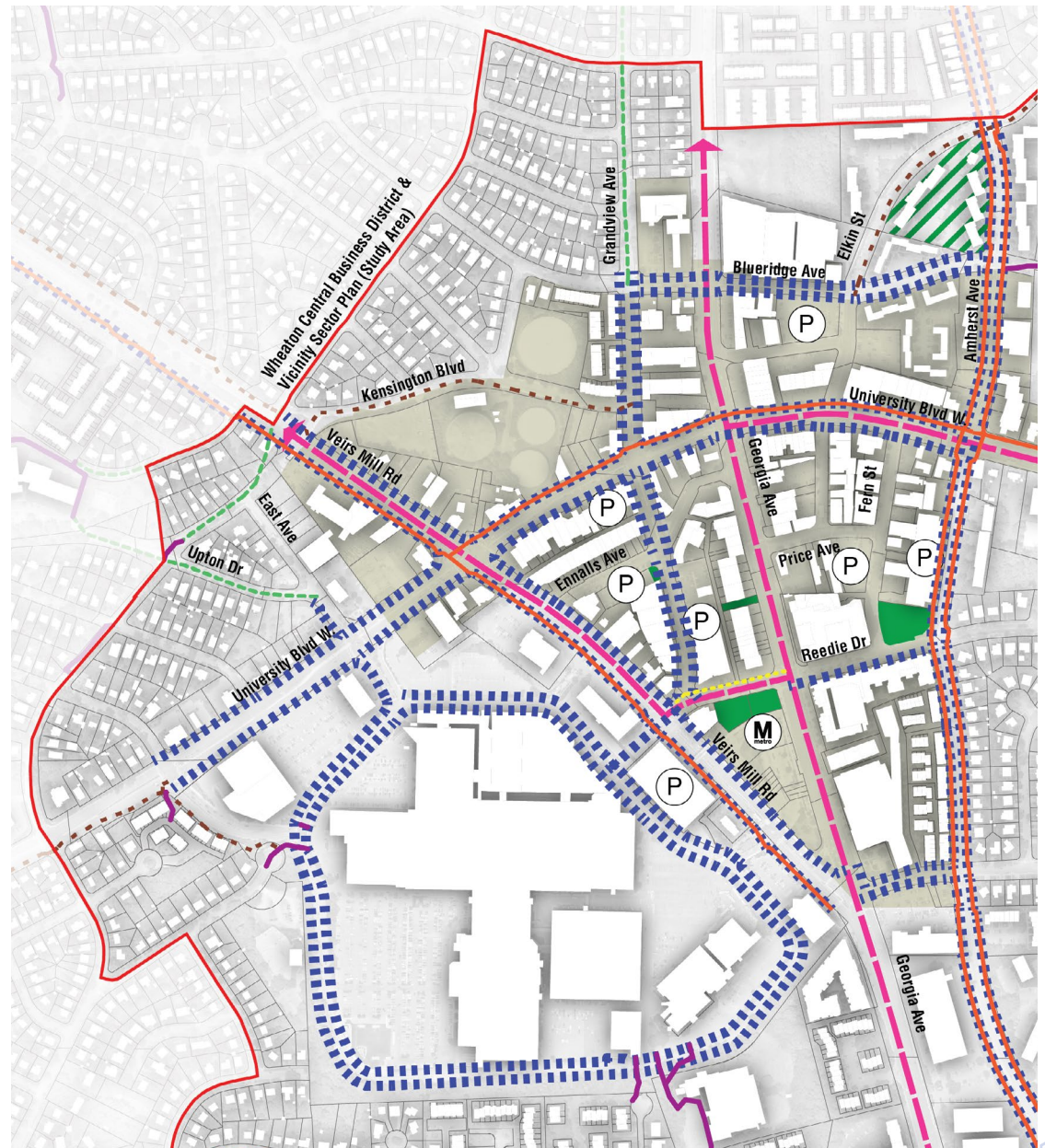
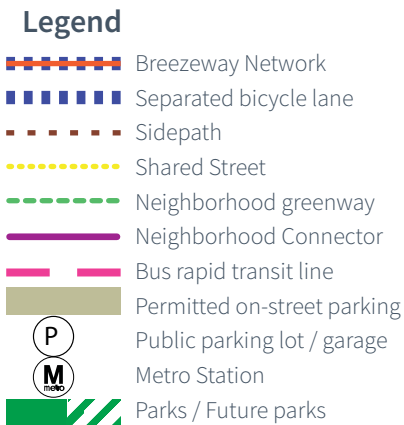

Figure 07: Planned Mass Transportation and Bicycle Network





BRIGGS CHANEY

cityp[ost]

A tall, vertical sign with a yellow top, orange middle, and blue and green bottom. It features the "cityp[ost]" logo at the top and a map of the transit route below.

Bus Rapid Transit Station

Existing Paving Materials

In the 10 years since Sector Plan approval, multifamily residential developments have been completed on several properties, including Arrive Wheaton, Solaire Wheaton, AVA Wheaton, and The George Apartments. The M-NCPPC Wheaton Headquarters (formerly known as the Wheaton Revitalization Project) was completed in 2020 and delivered over 300,000 square feet of office and ground floor retail space in the center of Wheaton.

Existing streetscape improvements have been implemented incrementally, by limited redevelopment efforts and by county-led sidewalk improvement efforts. Variations of the 2002 streetscape standards exist at several locations, but there are many areas where improvements are still needed.

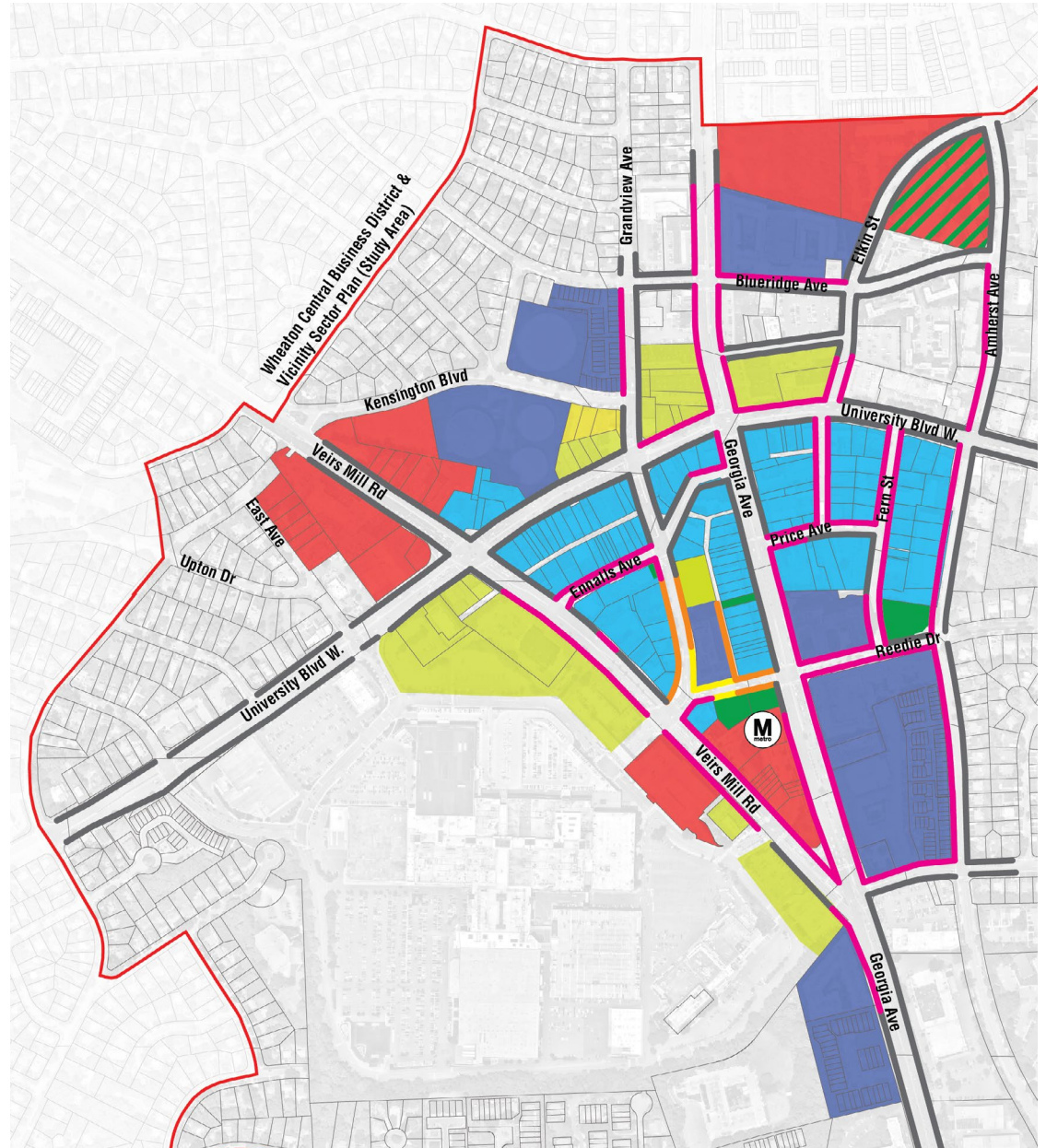

Figure 08: Existing Streetscape Types and Development Potential





Existing pavement conditions in downtown Wheaton



CHAPTER 3



Your Sign Here!

Your Sign Here!

WHEATON

NO SKATEBOARDING
Allowed On This Area
No Skateboards
No Roller Skates
No Roller Skis
No Scooters
No Skateboards
No Roller Skates
No Roller Skis
No Scooters

WHEATON

Streetscape Standards

Design Principles

The Wheaton Streetscape Standards will guide improvements along downtown streets as redevelopment and public infrastructure projects are implemented. Building upon the distinct character of the district and including strategic additions and enhancements to the existing streetscape palette, the standards follow a holistic approach to materials, elements, and programming adaptable to the various conditions found in the downtown area. Key principles include:

Build on Local Character

- Create an identifiable and unified public realm character for downtown Wheaton.
- Establish a standard paving material palette and pattern that integrates areas where streetscape was recently improved by new development.
- Establish Wheaton's Central Triangle area as downtown's center, featuring unified paving, lighting, and planting treatments.
- Prioritize downtown's three significant roadways (University Boulevard, Veirs Mill Road, and Georgia Avenue) as future boulevards and major placemaking corridors.
- Build upon the 2002 Wheaton Streetscape Standards in downtown areas immediately outside Wheaton's Central Triangle and reduce the number of streetscape types for clarity.

Improve Walkability and Safety

- Create an active, safe, walkable, and comfortable public realm for both residents and visitors.
- Integrate guidance from other county initiatives aimed at



improving transit access, reducing traffic fatalities and severe injuries, and addressing climate change.

Implementation Flexibility

- These standards can be adapted and updated as needs in the downtown area evolve.
- Adaptable standards to meet the needs of long-term private development and publicly funded infrastructure improvements.
- Provide alternatives for both interim and permanent streetscape improvements, including sidewalk paving and interim programming such as parklets and other flexible uses.

Promote Sustainable Practices

- Promote the implementation of green infrastructure to reduce the impacts from stormwater runoff through the use of on-site management and filtration systems.
- Include strategies such as increasing the street tree canopy to reduce the heat island effect within the district.

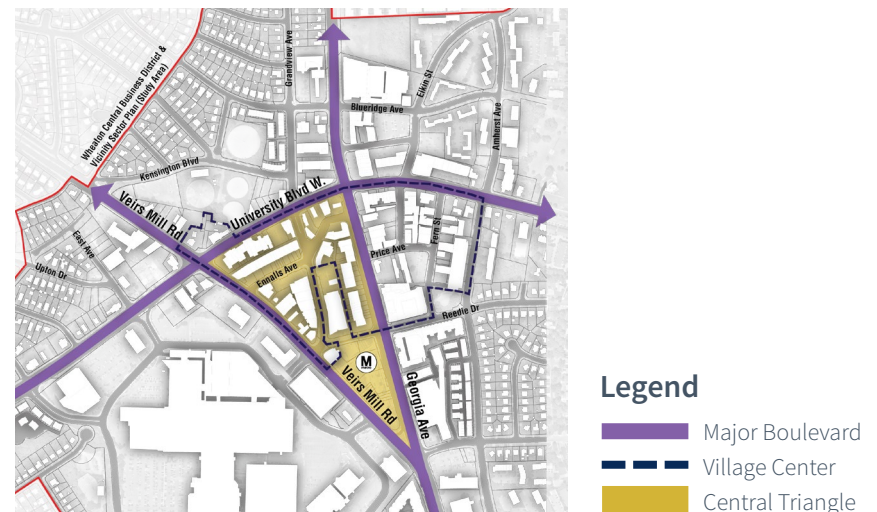

Figure 09: Wheaton's Center

Paving Overview

Materials

The proposed paving palettes have been developed to create a unified sense of place while providing high quality streetscape with opportunities for variety and special moments. The following are the four types of paving material palettes:

Concrete Unit Paving

Concrete unit pavers have been the standard streetscape paving material in downtown Wheaton for the last twenty years, proving to be a safe and durable paving product. Concrete unit pavers will continue to be the recommended paving outside of the Central Triangle defined by Veirs Mill Road, Georgia Avenue, and University Boulevard West. Concrete unit pavers will continue to use the red and natural buff colors from the currently used 2002 Streetscape Standards, with the addition of red, tan, and brown concrete unit accent pavers along street buffer zones to unify areas paved in concrete unit pavers to brick paved areas.

Clay Brick Paving

Clay brick pavers are a durable, timeless, and safe paving material that exists in many of Montgomery County's urban districts, including Downtown Silver Spring and Downtown Bethesda. These systems can perform as accessible pavements when proper design, construction and maintenance requirements are followed. Clay brick pavers can be found in downtown Wheaton in the surrounding streetscape environments around the M-NCPPC headquarters, and within Marian Fryer Town Plaza. Clay brick pavers are recommended to define Wheaton's Central Triangle area, bound by Veirs Mill Road, Georgia Avenue, and University Boulevard West. This will establish this area as a special district that emphasizes the downtown core and unifies future streetscape improvements with those introduced around M-NCPPC.

Permeable Paving

These guidelines recommend the development of ecologically sustainable streetscapes. Permeable pavers are recommended along public streets where feasible. These pavers should match the color and overall profile of proposed concrete unit pavers and clay brick pavers where prescribed.

Permeable paving requires site testing to determine soil conditions including percolation rate and infiltration capabilities; depth to seasonal high water table; depth to bedrock; and soil contamination. Impervious pavers are recommended where pervious pavers are not feasible.

Poured-In-Place Concrete Paving

Poured-in-place concrete is durable, has ease of maintenance, requires a lower cost relative to other materials, and can achieve flat and smooth surfaces for maximum accessibility (including ADA ramps and driveway areas). Poured in place concrete is recommended along neighborhood streets, at ADA ramps, at driveway/service access areas, and for pedestrian access through roadway medians.







Modified 2002 Streetscape Standards - Blueridge Avenue



Paving Plan Goals

- Establish a consistent and coherent paving palette that integrates recently completed, high quality streetscape improvements.
- Incorporate in the recommended streetscape types all paving materials in use in the downtown area.
- Reduce the number of streetscape types for clarity and ease of implementation, and concentrate each material in the areas where they are most prevalent.

Legend

-  Type 1 - Concrete Unit Paver
(Downtown Boulevard / Downtown Street)
-  Type 2 - Clay Brick Paver
(Downtown Boulevard / Downtown Street)
-  Type 3 - Poured-In-Place Concrete
(Neighborhood Street)
-  M-NCPPC Paver (Existing)

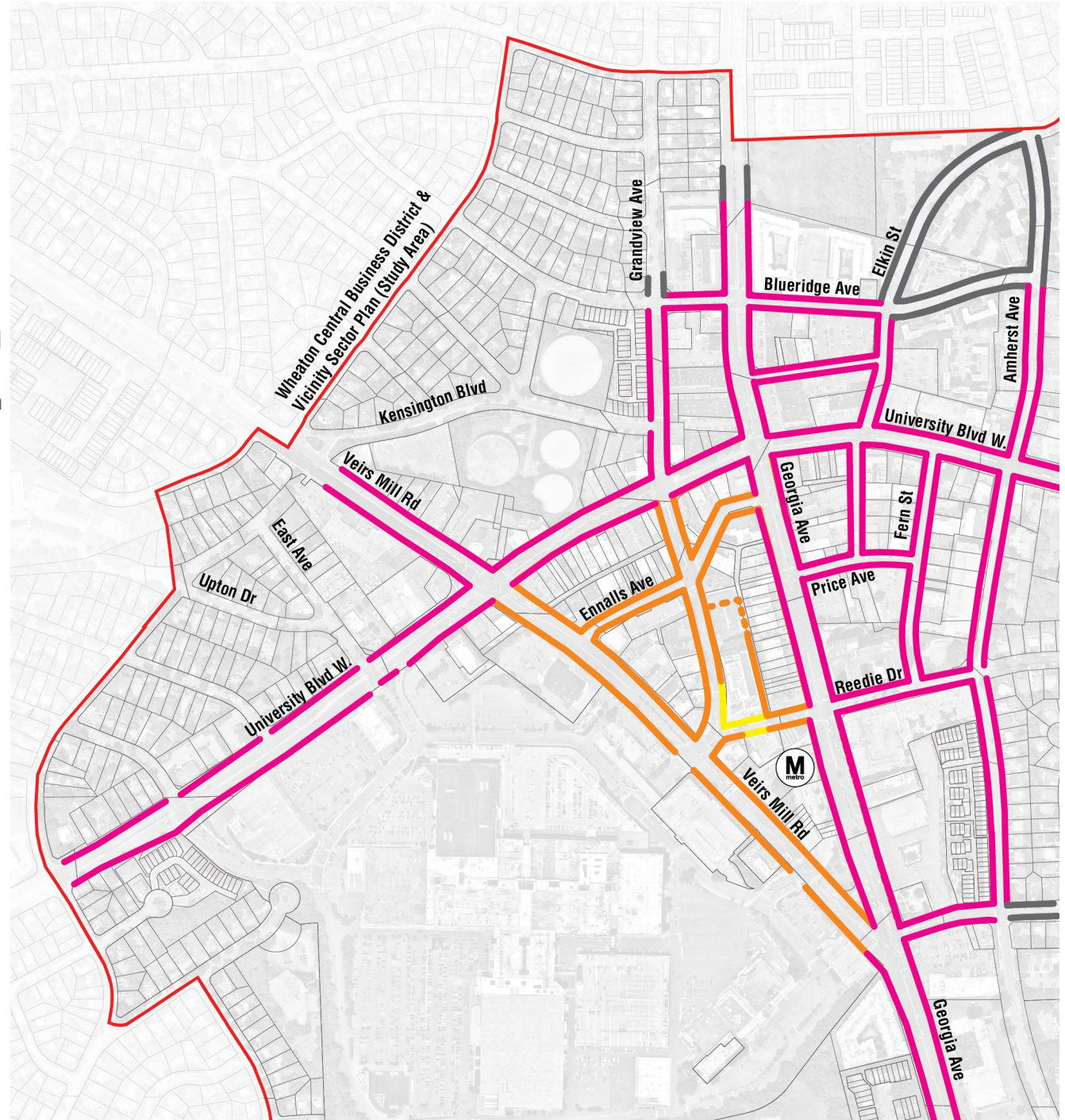

Figure 10: Paving Plan



Bicycle Facilities and Bus Routes

The streetscape types illustrated in the following pages include recommendations based on CSDG defined sidewalk zones between curb and building facade (buffer, sidewalk, and frontage zones). Recommended separated bicycle facilities and their associated street buffers should be constructed in coordination with the paving material and landscape recommendations of the applicable streetscape type.

Downtown Boulevards

The 2018 *Bicycle Master Plan* included bikeway recommendations for two of Wheaton's Downtown Boulevards (also, see Figure 07). A separated bikeway and a segment of the breezeway network on opposite sides of the road are recommended for University Boulevard West and Veirs Mill Road. As properties redevelop along these frontages, applicants should follow the guidance in Montgomery Planning's 2018 *Bicycle Facility Design Toolkit* for dimensional and configuration considerations to achieve facilities that are integrated with adjoining streetscape environment. Final dimensions for all street zones may vary depending on location, available space or specific property limitations. These will be established during the development review process.

Veirs Mill Road and Georgia Avenue have recommendations for Bus Rapid Transit (BRT) routes, which are subject to pilot projects at the time these standards are being completed. The *Wheaton Downtown Study* recommended reducing downtown boulevard's rights-of-way to shorten crossing distances within the downtown area, and also recommended exploring repurposing vehicular pavement along Veirs Mill Road to better connect the Westfield and Core Districts. If explored, this repurposing may adjust the positioning of bike and bus facilities and could potentially increase the extent of streetscape that could be implemented. Redevelopment planning along these frontages, particularly along Veirs Mill Road, should consider integrating these recommendations.

Downtown Streets

Bikeway facilities on Downtown Streets are being implemented by the Montgomery County Department of Transportation (MCDOT) along Amherst Avenue and Grandview Avenue as on-road facilities with reduced impacts to existing streetscape improvements. Future development along any of these areas should integrate bike facilities being implemented with any upgrades to streetscape areas.

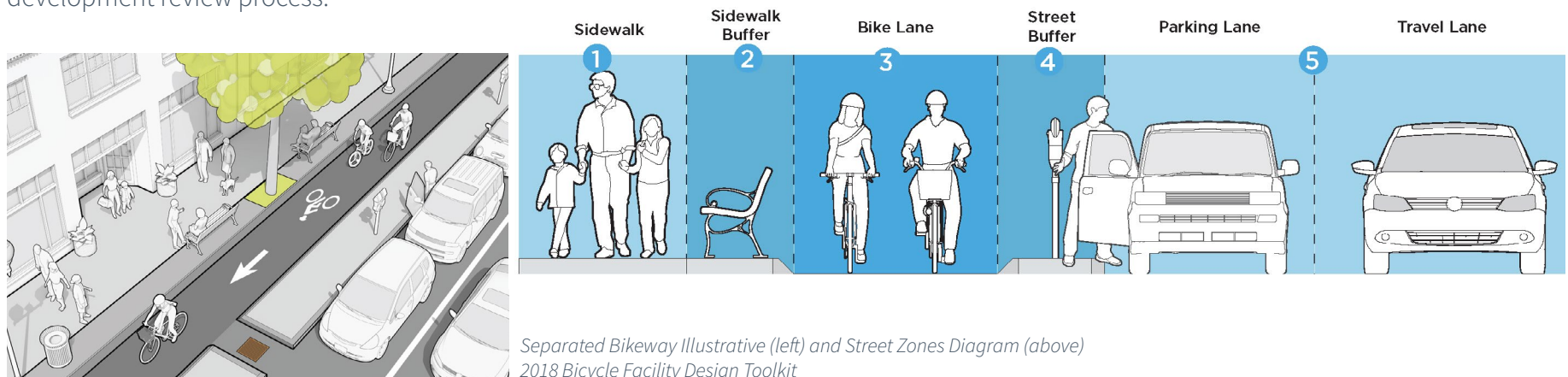

Accessible Routes

Streetscape types included in these standards recommend clay and concrete unit paver materials for consistency and continuity with existing improvements and to harmonize with the variety of streetscape environments that exist in Wheaton and preserve local character. Precast concrete pavers are the most commonly used material in downtown Wheaton. The Wheaton Headquarters of M-NCPPC, also in the Central Triangle, utilized clay brick pavers along the building's frontages, and in Marian Fryer Town Plaza.

Unit paver pathways compliant with federal accessibility guidelines are achievable if applicable industry standards are followed. ADA Accessibility Guidelines offers the following guidance, applicable to unit paver installations:

- Path surfaces shall be stable, firm, and slip resistant per ANSI A326.3.
- Openings in floor and ground surfaces shall not allow passage of a sphere greater than 1/2 inch (13 mm) in diameter.
- Changes in level up to 1/4 inch shall be permitted to be vertical.
- Detectable warning surfaces shall consist of truncated domes, compliant with Section 705 of the guidelines.
- Detectable warning surfaces shall contrast visually with adjacent walking surfaces.
- Technical Note 14E, developed by The Brick Industry Association describes best practices suitable to achieving accessible routes with unit pavers, in conformance with ADA Guidelines.

While not addressed in the ADA Accessibility Guidelines, anecdotal information regarding how pavement roughness may cause discomfort for wheelchair users exists. The Planning Board Draft of *Montgomery County's Pedestrian Plan* (MCPD) includes recommendations within its Expand Access section on this topic; following CSDG zones, the Pedestrian Plan recommends a preference for poured-in-place concrete for the sidewalk zone, allowing for other types of paving materials to be used in the buffer and frontage zones.

These standards will prioritize concrete or clay brick unit paver materials in the downtown area, stressing accessibility as an important consideration. Local character is also an important factor; significant investment in unit paver pavements has occurred in downtown Wheaton over the years, establishing visual character for the area. Concrete paver and clay brick pavers installed in connection with redeveloped properties have followed ADA guidelines and have performed well over time, showing that accessible routes are possible with unit paver pavements. Poured-in-place concrete is also included as an alternative for the sidewalk zone only to be considered by applicants during the development review process.



Example of streetscape in downtown Silver Spring that combines poured-in-place concrete areas with unit paver areas.



Streetscape Standards | Type 1 | Typical Layout

8x8 feet Wheaton paving module field; Tree/planting buffer zone with 18x18 inch variegated color pavers

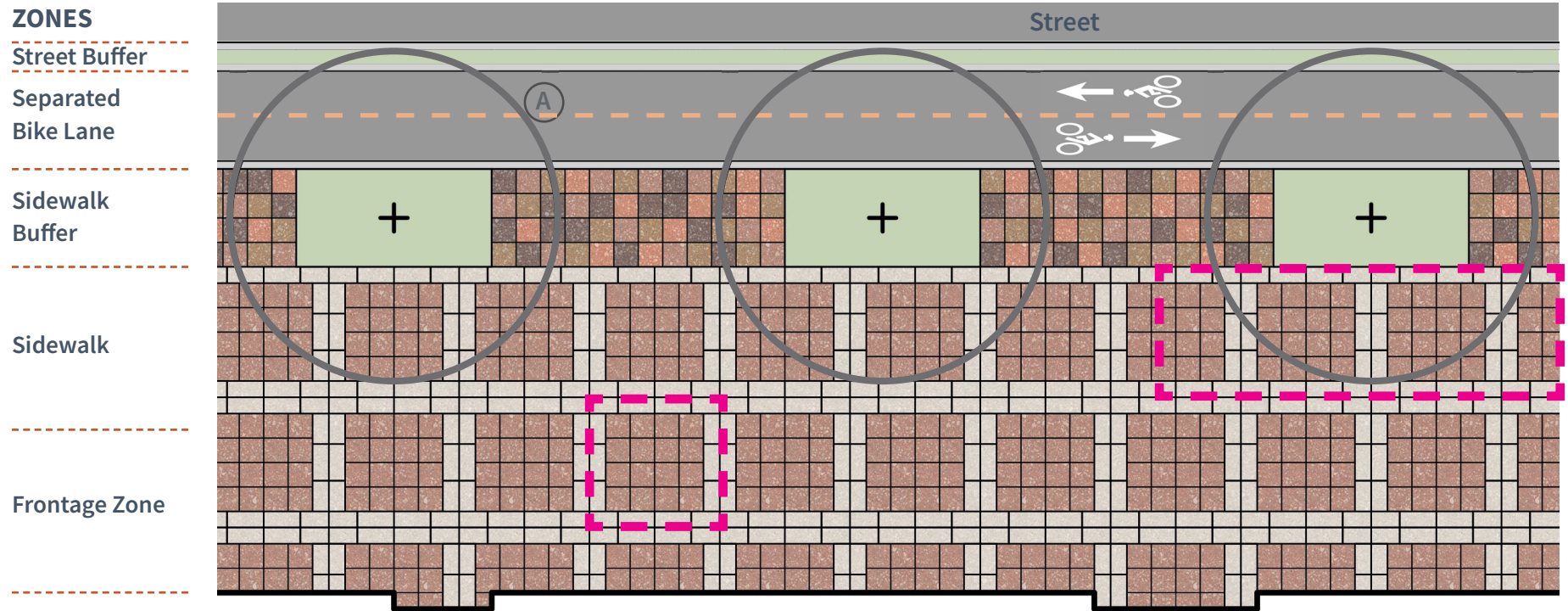

Legend

- (A)** Street Tree, 30 feet on-center min., typical
- (B)** 18 x 18in pavers (color varies), stacked bond
 - Hanover Prest Pavers - Quarry Red (20%)
 - Hanover Prest Pavers - Red (20%)
 - Hanover Prest Pavers - Tan (20%)
 - Hanover Prest Pavers - Brown (20%)
- (C)** Tree / Planting Well
- (D)** 8 x 8 ft. Wheaton Standard Paving module
 - 12 x 24 in. Band - Hanover Prest Pavers - Natural
 - 18 x 18 in. Field - Hanover Prest Pavers - Red
- (E)** Poured-in-Place Concrete Alternate (Sidewalk Zone Only)

Zone	Downtown Boulevard	Downtown Street
Bike Lane/ Street Buffer	Refer to Bicycle Facility Design Toolkit for dimension recommendations.	Refer to Bicycle Facility Design Toolkit for dimension recommendations.
Sidewalk Buffer	8 feet default; 6 feet minimum 0 feet if Frontage Zone less than 10 feet	6 feet default; 11 feet if combined w/ on-street parking
Sidewalk	15 feet default; 10 feet minimum	10 feet default; 8 feet minimum
Frontage Zone	10 feet default; 0 feet minimum	10 feet default; 0 feet minimum

Zone Dimensions Table per CSDG Street Type



Streetscape Standards | Type 1 | Downtown Boulevard

8x8 feet Wheaton Paving Module Field; Tree/Planting Buffer Zone with 18x18 inch Pavers

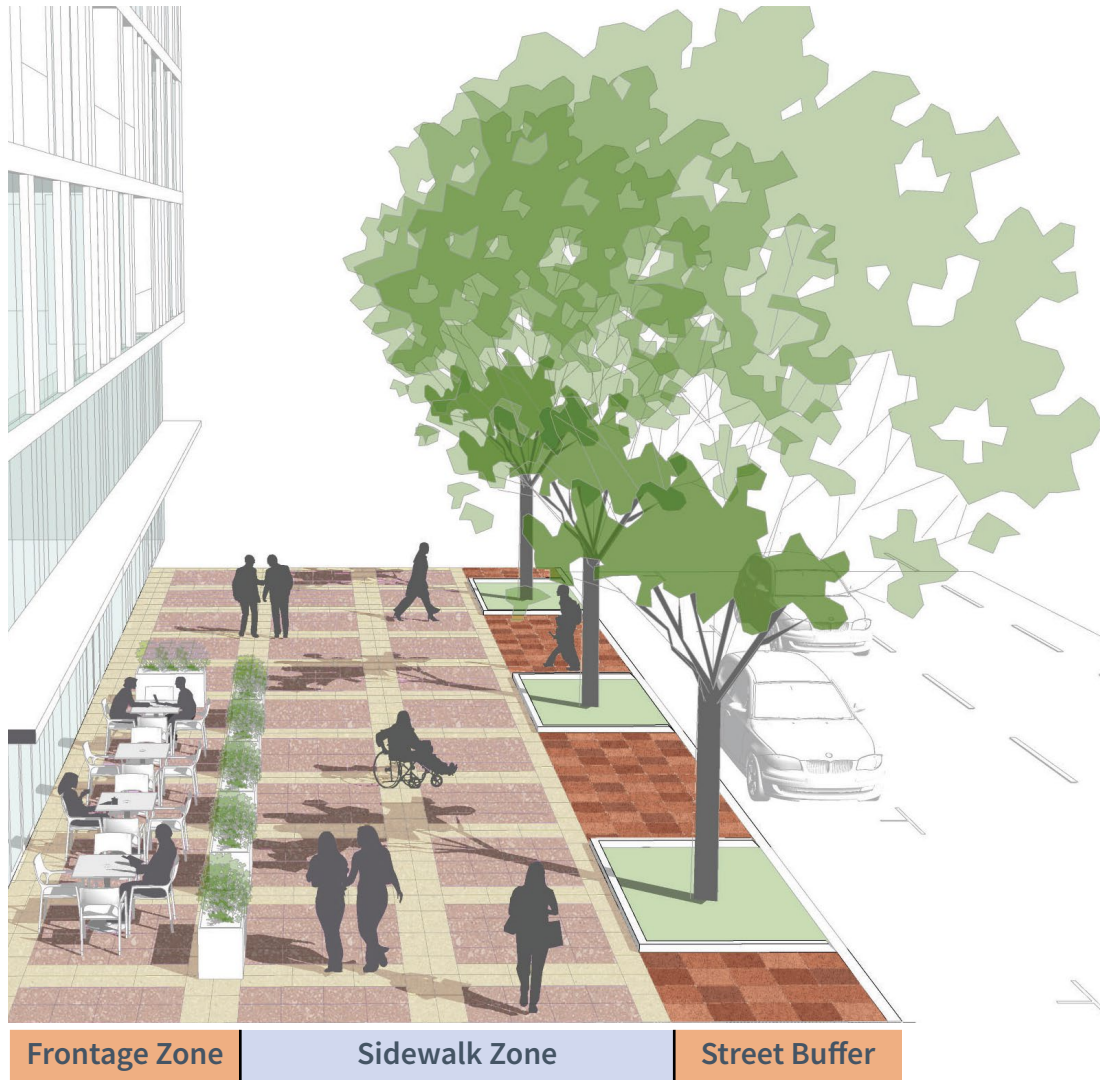

Note:

- Bikeway facility recommendations are not included in the illustrative above. Facilities will vary depending on location. Refer to the 2018 *Bicycle Master Plan* for recommendations along Downtown's Boulevards.

Design Considerations

- Dimension for each zone will vary depending on location, available space, and development particulars. These should be established during the development review process.
- Prioritize concrete pavers. Poured-in-place concrete may be used within the sidewalk zone in lieu of the recommended Wheaton Paving Module.
- Street buffer will consist of four different colored concrete pavers, as specified. Twenty-five percent of each color, random pattern.
- Integrate construction of recommended separated bikeways with streetscape type material requirements. Refer to the *Bicycle Facility Design Toolkit* for additional information on bikeway dimensions.



Wheaton Paving Module



Streetscape Standards | Type 1 | Constrained Layouts

Type 1A - Single 8x8 ft Wheaton Standard Paving Module with tree / planting well

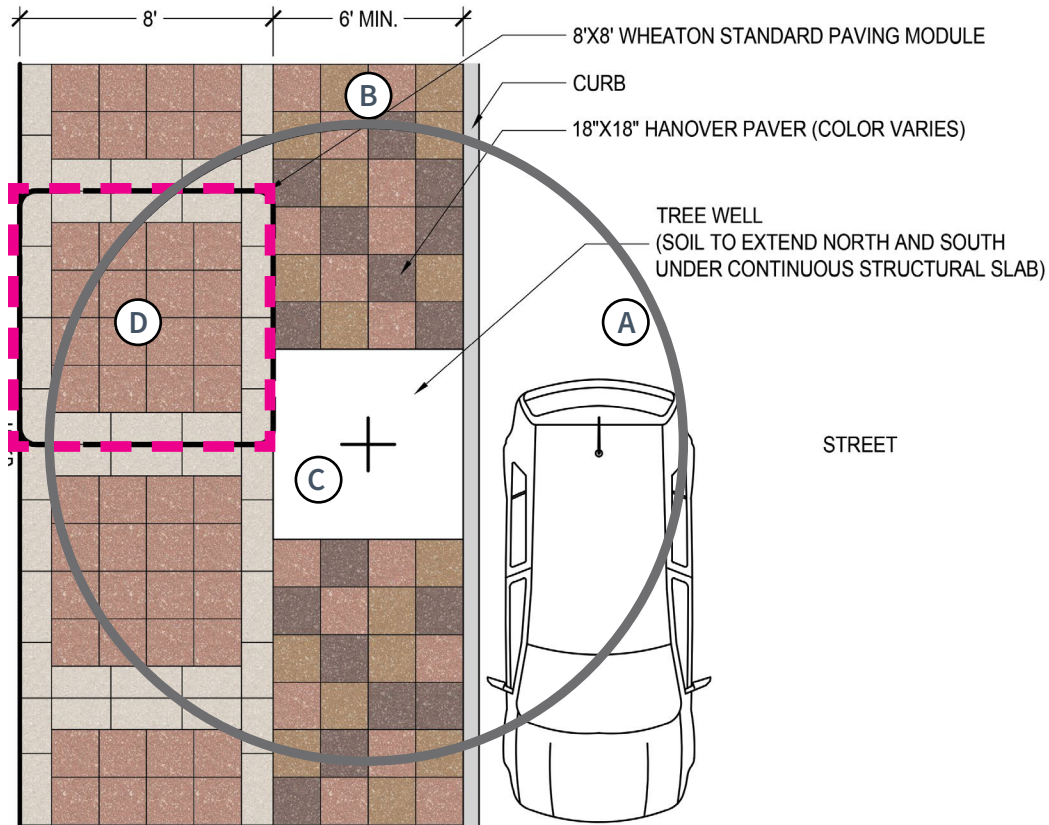

Type 1B - Single 8x8 ft Wheaton Standard Paving module

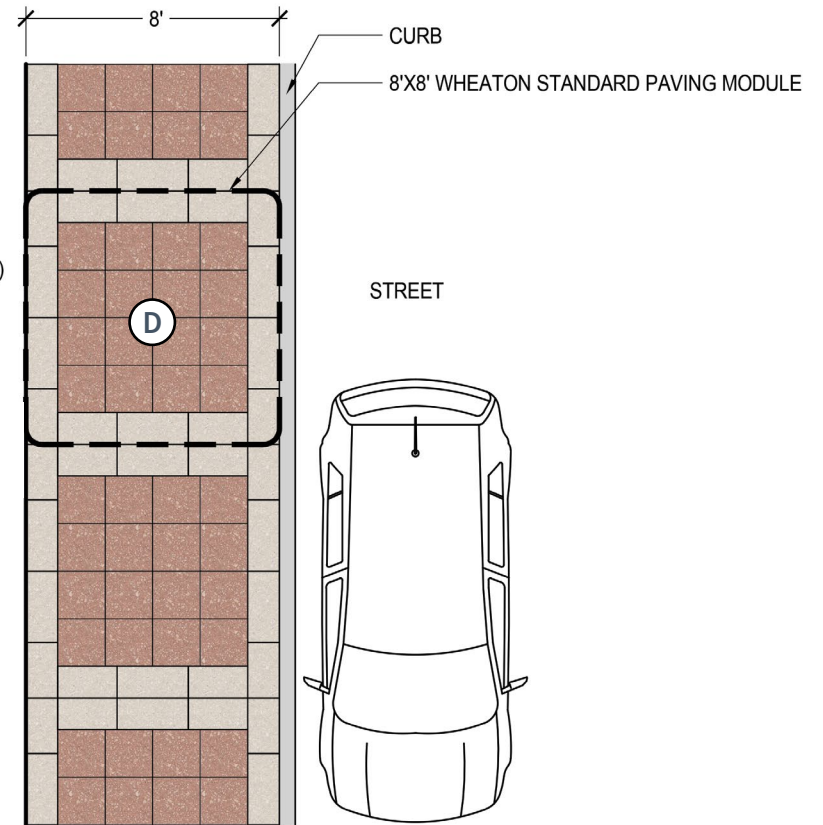

(A) Street tree, 30 feet on-center minimum, typical.

- (B) 18 x 18 in. pavers (color varies), stacked bond.
- Hanover Prest Pavers - Quarry Red (20%)
 - Hanover Prest Pavers - Natural (20%)
 - Hanover Prest Pavers - Red (20%)
 - Hanover Prest Pavers - Tan (20%)
 - Hanover Prest Pavers - Brown (20%)

(C) Tree / Planting Well

- (D) 8 ft x 8 ft Wheaton Standard Paving Module
- 12 x 24 in. Band Paver: Hanover Prest Pavers - Natural
 - 18 x 18 in. Field Paver: Hanover Prest Pavers - Red



Streetscape Standards | Type 1 | Downtown Street

Multiple 8x8 feet Wheaton paving module field; Tree/planting buffer zone with 18x18 inch pavers

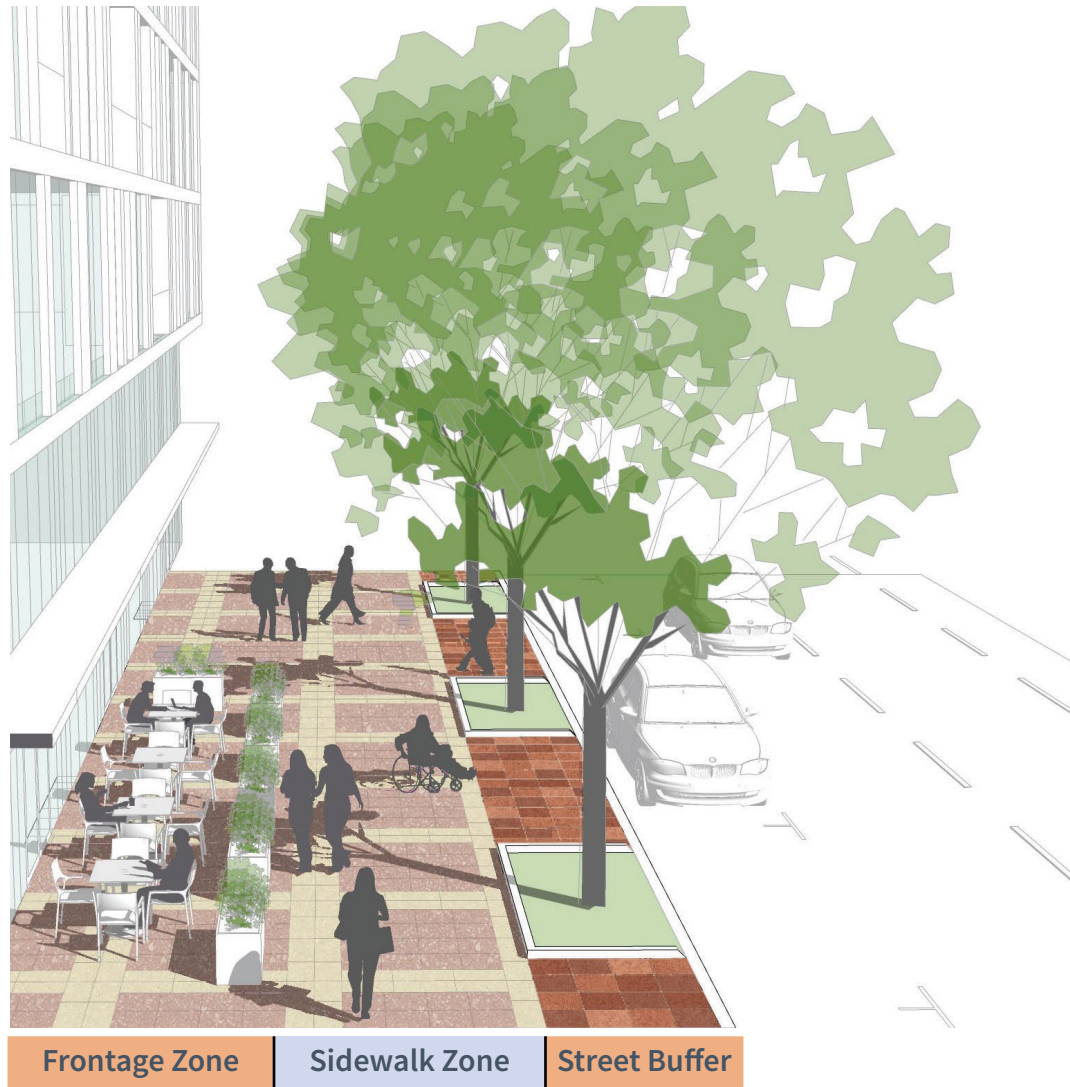

Note:

- Bikeway facility recommendations are not included in the illustrative above. Facilities will vary depending on location. Refer to the 2018 *Bicycle Master Plan* for recommendations along Downtown's Boulevards.

Design Considerations

- Dimension for each of the zones will vary depending on location, available space, and application particulars. These should be established during the development review process.
- In constrained areas where space for the frontage zone may not be available, poured-in-place concrete may be used for the sidewalk zone.
- Buffer zone will consist of four different colored concrete pavers, as specified. Twenty-five percent of each color, random pattern.



Wheaton Paving Module



Streetscape Standards | Type 2 | Typical Layout

Clay brick paver field; Tree/planting buffer zone with 8x8 inch pavers

ZONES

Street Buffer

Separated
Bike Lane

Sidewalk
Buffer

Sidewalk

Frontage Zone

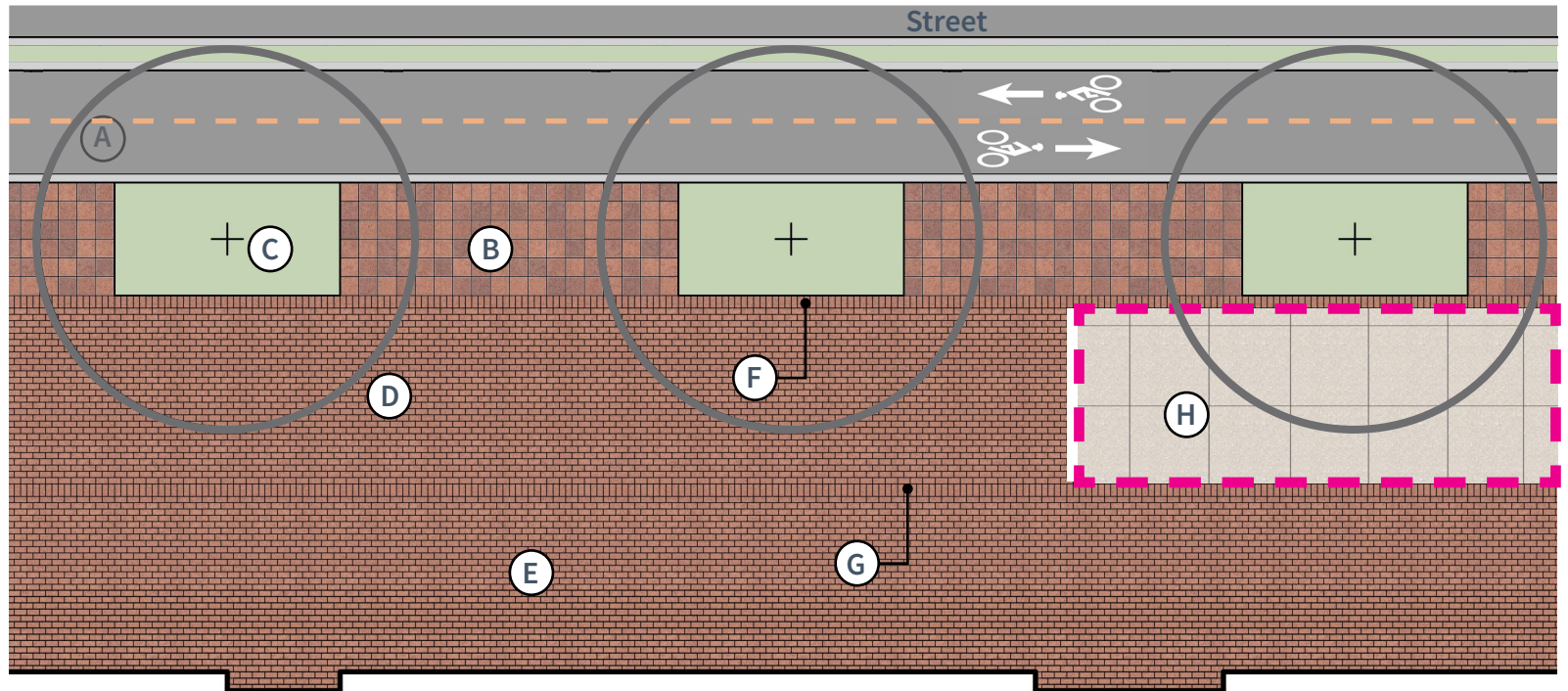

Zone	Downtown Boulevard	Downtown Street
Bike Lane / Street Buffer	Refer to Bicycle Facility Design Toolkit for dimension recommendations.	Refer to Bicycle Facility Design Toolkit for dimension recommendations.
Sidewalk Buffer	8 feet default; 6 feet minimum 0 feet if Frontage Zone less than 10 feet	6 feet default; 11 feet if combined w/ on-street parking
Sidewalk	15 feet default; 10 feet minimum	10 feet default; 8 feet minimum
Frontage Zone	10 feet default; 0 feet minimum	10 feet default; 0 feet minimum

Zone Dimensions Table per CSDG Street Type

Legend

- (A)** Street tree, 30 feet on-center minimum, typical.
- (B)** 8 x 8 in. Brick pavers (color varies), stacked bond.
 - Endicott Clay Products - Coppertone (25%)
 - Endicott Clay Products - Medium Ironspot #77 (30%)
 - Endicott Clay Products - Medium Ironspot #46 (15%)
 - Endicott Clay Products - Dark Ironspot (10%)
 - Beldon Brick - #470-479 (20%)
- (C)** Tree / planting well.
- (D)** **(E)** 4 x 8 in. Brick Paver (Beldon Brick - #470-479), running bond.
- (F)** **(G)** 4 x 8 in. Brick Paver (Beldon Brick - #470-479), soldier course at transition between street buffer and sidewalk, and between sidewalk and building face.
- (H)** Poured-in-place Concrete Alternative (sidewalk zone only).



Streetscape Standards | Type 2 | Downtown Boulevard and Downtown Street

Clay brick paver field; Tree/planting buffer zone with 8x8 inch pavers

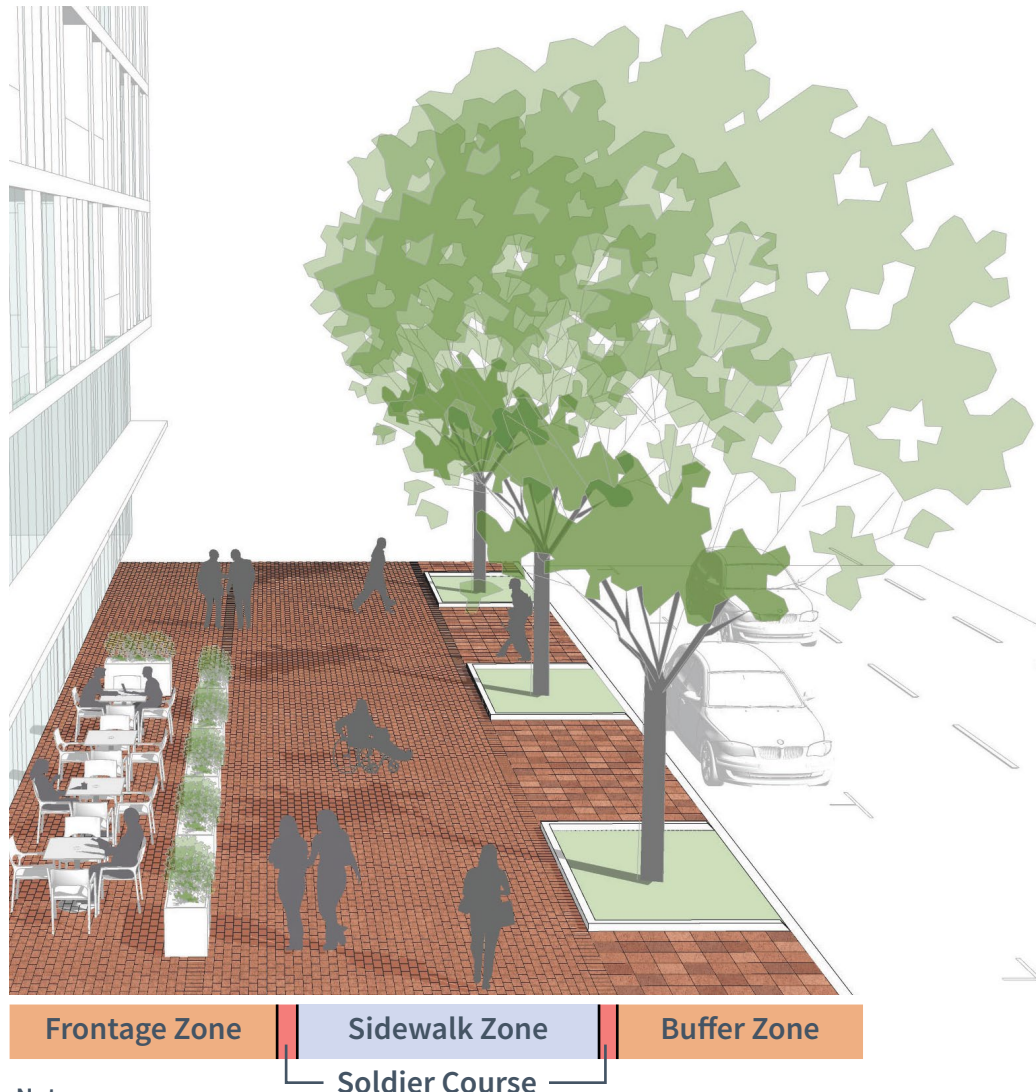

Note:

- Bikeway facility recommendations are not included in the illustrative above. Facilities will vary depending on location. Refer to the 2018 *Bicycle Master Plan* for recommendations along Downtown's Boulevards.

Design Considerations

- Dimension for each of the zones will vary depending on location, available space, and application particulars. These should be established during the development review process.
- Poured-in-place concrete may be used within the sidewalk zone in lieu of the recommended Clay Brick Paver.
- Buffer zone will consist of variegated 8x8 in. brick paver, in the colors specified.
- If applicable, integrate construction of recommended separated bikeways with streetscape type material requirements. Refer to the *Bicycle Facility Design Toolkit* for additional information.



Example of Sidewalk Zone (1) and Buffer (2) paving material.



Streetscape Standards | Type 3 | Typical Layout

Poured-in-place Concrete Paving

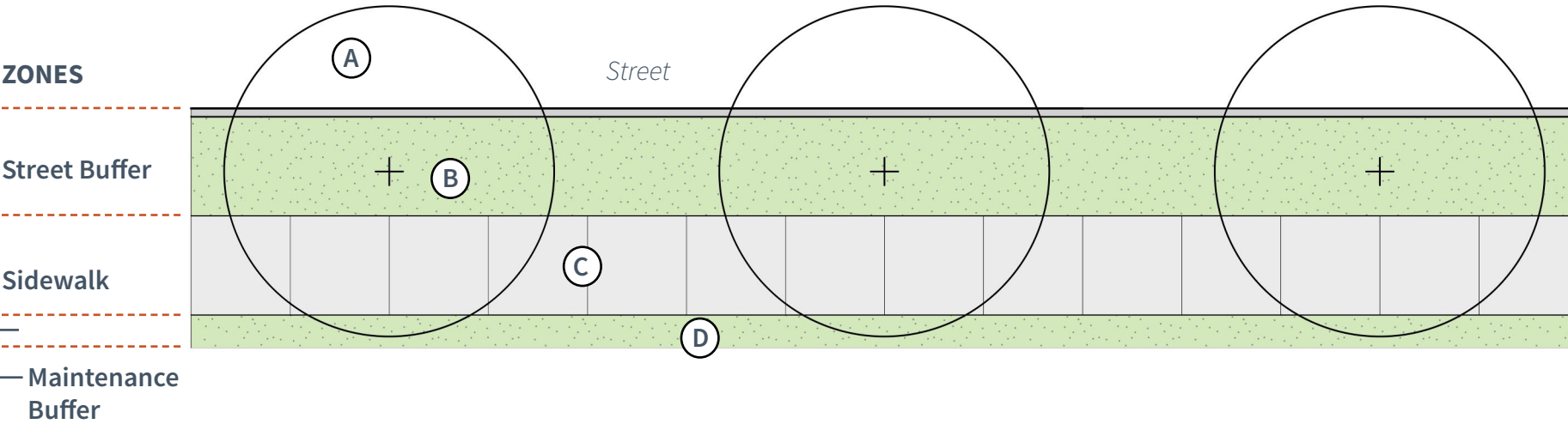

Zone	Neighborhood Street
Street Buffer	8 feet default; 6 feet minimum
Sidewalk	8 feet default; 6 feet minimum
Maintenance Buffer	2 feet default

Zone Dimensions Table per CSDG Street Type

Legend

- (A) Street Tree, 30 feet on-center min., typical
- (B) Continuous Lawn Panel
- (C) Poured-in-place Concrete Sidewalk
- (D) 2 ft Maintenance Buffer



Streetscape Standards | Type 3 | Neighborhood Street

Poured-in-place Concrete Paving



Sidewalk | Buffer Zone
Maintenance Buffer

Design Considerations

- Dimension for each of the zones will vary depending on location, available space, and application particulars. These should be established during the development review process.
- Buffer zone will consist of a continuous planter with trees selected from Montgomery County’s list of approved street trees.



Installation Considerations

Materials

The following are the four types of paving material palettes:

Concrete Unit Paving

Concrete unit pavers allow for quick removal and replacement to access utilities and other underground services. The proposed concrete unit pavers are off-the-shelf products that do not require special production.

- Ensure that the installation base is designed and constructed properly to avoid differential settlement (a concrete sub-base is recommended).
- Uneven, broken or damaged pavement will need to be removed and replaced over time.
- Paver surfacing shall include a textured surface to reduce slippage for pedestrians.
- Inspect and maintain pavements on a regular basis, at least once a year.

Clay Brick Paving

Clay pavers are chosen for their durability, long-lasting color, small scale, and ability to blend in with the surrounding area. In Montgomery County, clay brick pavers have defined distinct business districts, including Silver Spring and Bethesda, and can be found within countless public and private-public realm projects.

Pavements composed of clay brick pavers must be able to accommodate many types of traffic, including pedestrians with physical disabilities. To ensure ADA compatibility, the following measures are recommended:

- Ensure that the installation base is designed and constructed properly to avoid differential settlement (a concrete sub-base is recommended).
- The surface level of a pavement should not vary more than $\frac{3}{8}$ in. (10 mm) within a 10 ft (3 m) measurement.
- Lippage between two pavers or a paver and the surrounding elements should be no more than $\frac{1}{8}$ in. (3 mm) for an accessible route.
- Minimize joint and chamfer widths to control vibration experienced by wheeled devices (a running bond pattern is recommended to meet this requirement). The maximum joint or gap between pavers or adjacent elements should be no more than $\frac{1}{2}$ in. (13 mm).
- Select appropriate trees and plants for locations near brick pavements, and employ root barriers or other best management practices to accommodate them.
- Inspect and maintain pavements on a regular basis, at least once a year.
- Refill sand in the joints in sand-set brick paving assemblies when necessary.
- Remove snow and ice as quickly as possible using appropriate tools or machines.
- Repair pavements that inhibit accessibility as soon as practical.
- Utilize poured-in-place concrete for all curb ramps and driveway crossings.
- Brick pavers shall include a wire-cut, textured surface. Install brick pavers texture side up to reduce pedestrian slippage.



Permeable Paving

Permeable pavers allow for quick removal and replacement to access utilities and other underground services. Permeable pavers are off-the-shelf products that do not require special production.

- Requires periodic maintenance to retain its infiltration capacity.
- Permeable pavement should be vacuumed once or twice annually. Vacuuming has been found to be most effective when sediments are dry. If routine cleaning does not restore infiltration rates, then partial or full reconstruction of the pervious surface may be required. Once a year, the paving should be tested to determine if it is clogged.
- Uneven, broken or damaged pavement will need to be removed and replaced over time.
- Inspect and maintain pavements on a regular basis, at least once a year.
- If permeable paving is considered appearance must match that of recommended paving materials.

Poured-in-Place Concrete Paving

Overall, a long-lasting paving material. Does not allow for ease of removal and replacement compared to concrete unit pavers or brick.

- Poured-in-Place concrete may become unattractive over time due to patching for repairs and to access underground utilities.
- Uneven, broken or damaged pavement will need to be removed and replaced over time.
- Inspect and maintain pavements on a regular basis, at least once a year.



Installation Details

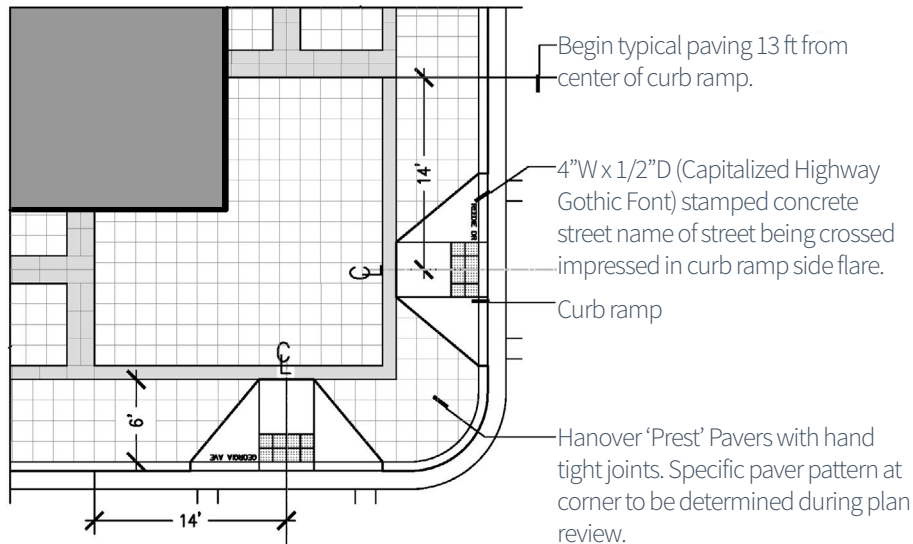

Plan - Street Corner Crossing - Type 1 Layout

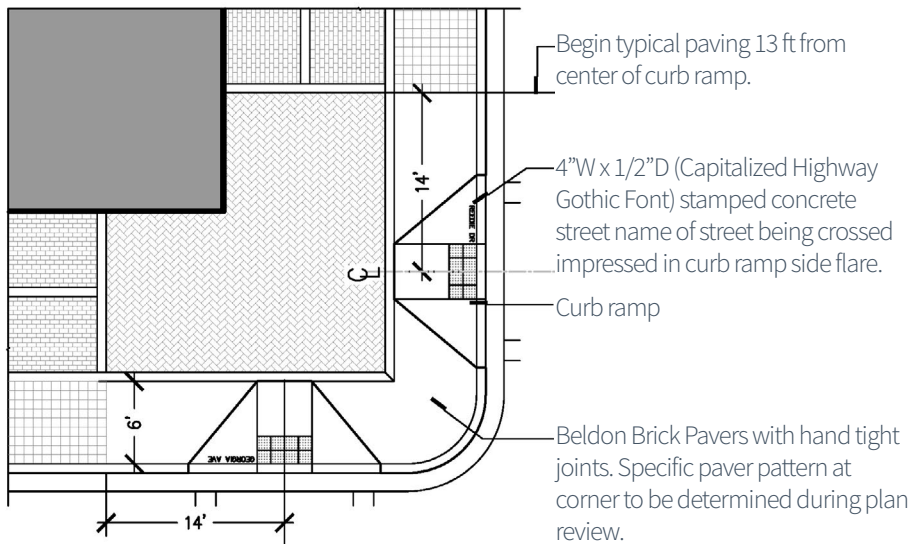

Plan - Street Corner Crossing - Type 2 Layout

Crosswalk Ramps

Ramp placement may be affected by the location and placement of streetscape elements and utilities, including catch basins. The location of fixed objects (e.g., poles, signal cabinets, etc.) should not limit access for pedestrians and bicyclists using sidewalks and curb ramps.

- Curb ramps and crosswalks should be designed to drain water away from curb ramps, reducing risk of pooling (and icing) across ramps.
- The Montgomery County preferred standard is two perpendicular curb ramps per corner, each aligning with desired paths of travel.
- All curb ramps must be compliant with the United States Access Board Public Right-of-Way Accessibility Guidelines.
- Ramps shall be comprised of poured-in-place-concrete.

Driveway Ramps

- The driveway ramp should be contained within the Street Buffer Zone to avoid a cross slope on the sidewalk.
- Driveway design must meet current ADA standards. Driveways should always remain at sidewalk level when crossing a sidewalk or cycletrack.
- The frequency of driveways should be minimized. Locate driveways with adequate clearance from the intersections.
- Driveway ramps and driveways shall be paved with poured-in-place concrete.





Curb Extensions

- Curb extensions are created by extending the sidewalk or curb line into the street (typically width used for a parking lane) at an intersection or mid-block crossing location in order to shorten the crossing distance for pedestrians and improve visibility at crossing locations. By physically and visually narrowing the street, curb extensions also have a traffic-calming effect.
- Curb extensions are strongly recommended on all streets that have on-street parking and can be used selectively in other locations. Curb extension installation on both sides of a crossing is preferred, but where curb extension installation on one side is infeasible or inappropriate (i.e., no parking lane), this should not preclude installation on the opposite side.
- Curb extensions may be planted or comprised of hardscape to increase the pedestrian realm. Planting within curb extensions should not impact sight distance.

Bus Bulbs

- Bus bulbs are elongated curb extensions that may be located mid-block or near intersections. Bus bulbs may include bus shelters, furnishings such as benches and movable cafe seating such that they do not obstruct access for loading and alighting.



Examples of existing driveways using brick and concrete pavers.



Sustainability Considerations

Environmental Site Design

As streetscape environments are redeveloped, applicants should explore alternatives to reduce imperviousness combined with building strategies to control stormwater runoff. In addition, increasing tree canopy and plantings and pursuing strategies to mitigate heat island effect will increase comfort in the public realm.

The percentage of paved, impervious surface area has steadily increased in urban areas, contributing to record reductions in groundwater resources, decreased water quality, and increased stress on municipal sewer systems, especially combined systems. This has contributed to a greater risk of damage caused by erosion and flooding. Environmental Site Design (ESD) and Structural Stormwater Management (SWM) effectively reduce the impact of untreated runoff. Effective stormwater management will reduce stormwater volume, reduce stormwater peak runoff discharges, and will improve water quality.

A series of small-scale connected stormwater facilities is called a 'treatment train'. When one treatment facility reaches capacity, the stormwater overflow is directed into another via a drainage channel or pipe network. In an urban environment, post-treatment is connected to the larger municipal storm/sewer system. The benefit of employing a train of small-scale facilities is achieving a greater level of stormwater treatment. Some Environmental Site Design facilities to consider in Wheaton should include:

- Micro-Bioretention
- Vegetated Planter Box
- Dry Swale
- Bioswale
- Permeable Pavements

Hard surfaces:
Impervious - Roads, roofs, large areas of pavement and asphalt parking lots

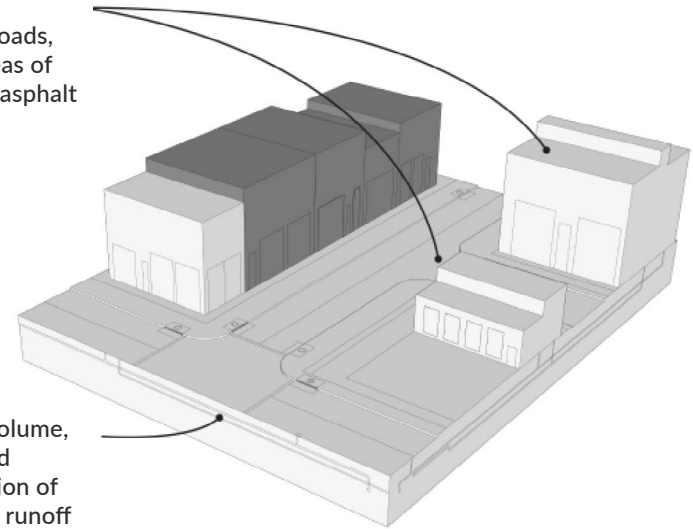

Increased volume, velocity, and contamination of stormwater runoff

Impervious Design Urban Surfaces

Soft surfaces:
Pervious/Permeable - Green roofs, rain gardens, grass-paver parking lots, bio-swales, and more

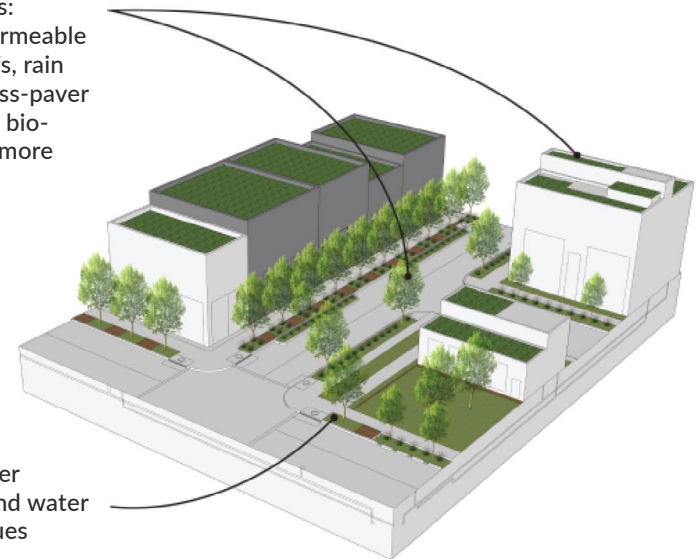

Increased groundwater recharge and water quality values

Pervious Design Urban Surfaces





Examples of sustainable materials and facilities (clockwise from top left): Permeable pavers; Sidewalk bioswale; Sidewalk rain garden, Vegetated roof and solar panels



CHAPTER 4

The image features a vibrant scene of a city street lined with lush green trees. In the background, a multi-story building with windows is visible. A blue diagonal overlay covers the top-left and bottom-right corners of the image. The text 'CHAPTER 4' is prominently displayed in the center in a large, white, sans-serif font, following the curve of the diagonal.

Streetscape Trees and Groundcover

Street Trees

Overview

As the District continues to evolve, providing opportunities for increasing the tree canopy will increase pedestrian comfort and help to create an identifiable sense of place. A street tree planting approach has been created that will diversify Wheaton's tree canopy without detracting from the visual clarity of the streetscape. The following are critical elements of the street tree planting approach:

- Monocultures are vulnerable to disease. Diversity of the tree species is recommended to protect the existing and future tree canopy.
- Several corridors include existing, healthy street trees. These street trees should be retained and protected. The street tree guidelines contained in this document will serve as a guide for future replacement of street trees.
- Ensure adequate soil volume to support the growth of healthy mature street trees and vibrant understory plantings.
- All new tree plantings must be a minimum of 2-5-inch caliper in size.



Examples of existing street trees in downtown Wheaton



Planting Approach

Georgia Avenue

Willow Oak

Georgia Avenue is the primary gateway corridor into downtown Wheaton from Silver Spring/I-495. The corridor is envisioned as an urban boulevard consisting of species of oak trees placed approximately 30' on-center. The oak trees will create a unified streetscape character that provides a consistent canopy, a sense of enclosure, and a memorable character along Georgia Avenue. The rhythmic form of the trees will also serve to visually reduce the scale of the wide corridor.



Hightower Willow Oak

Oaks

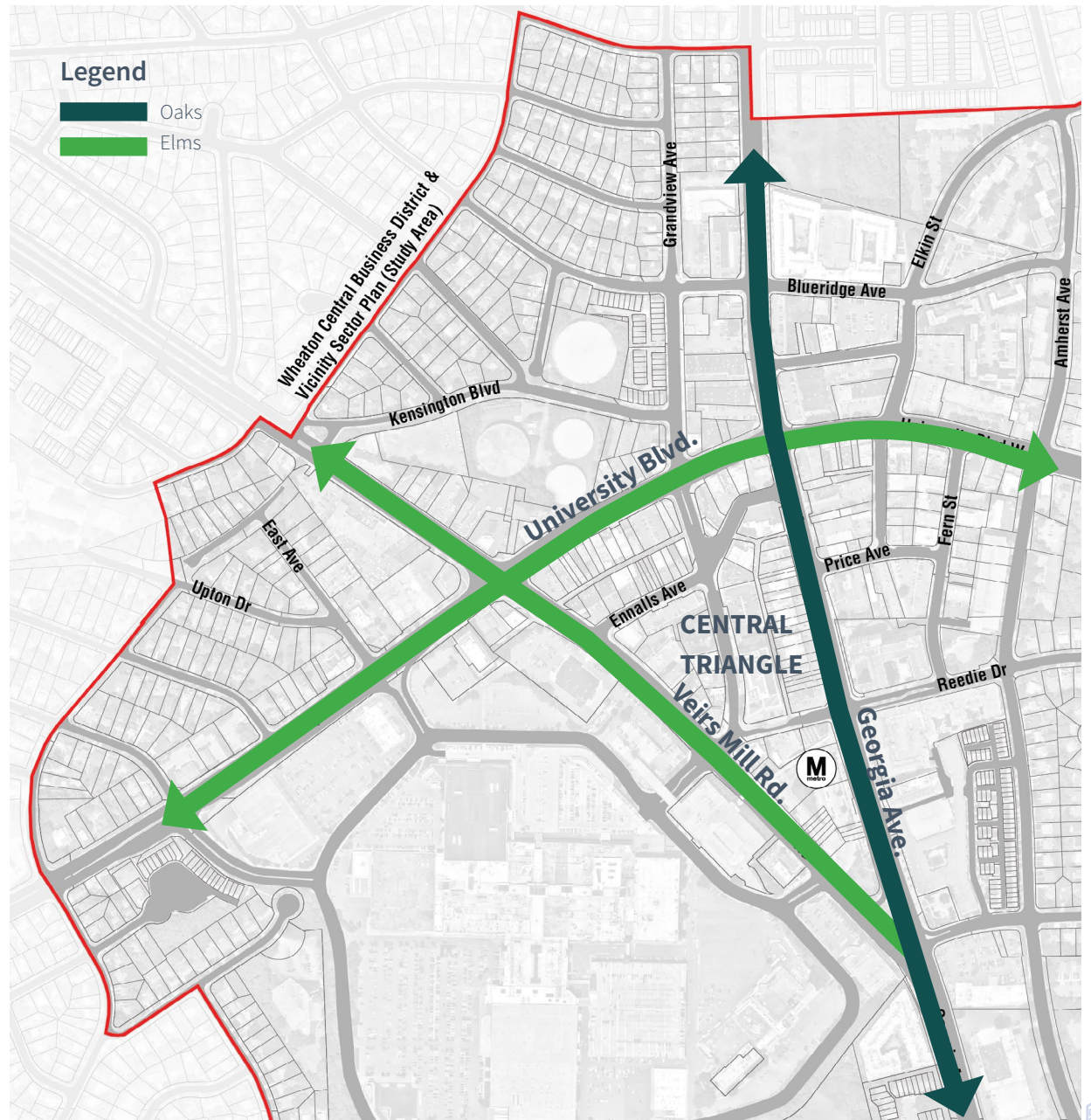

Figure 11: Tree planting approach for Wheaton's Downtown Boulevards



Veirs Mill Road and University Boulevard West

American Elm

These are two urban boulevards that together with Georgia Avenue form the edges of downtown Wheaton's Central Triangle. These corridors will be emphasized by a mix of species of elm trees placed approximately 30' on-center. The elm's vase-shaped form will create a distinctive landscape form while providing adequate shade to adjacent pedestrian zones.

No more than five trees of the same elm species are to be planted consecutively.

Public Streets and Privately Owned Streets

3 to 5 Species Mix

Street trees may include any selection from Montgomery County's list of approved street trees. Informal groupings of trees are encouraged to help define internal spaces and to maximize unique programming opportunities that further activate the streetscape environment.

Tree plantings should emphasize a diversity of native species and maximize tree canopy coverage to provide adequate shade along sidewalks.



Valley Forge American Elm



Persian Ironwood



Dura Heat River Birch



October Glory Red Maple

Elms

3-5 Species Mix



Tree Organization

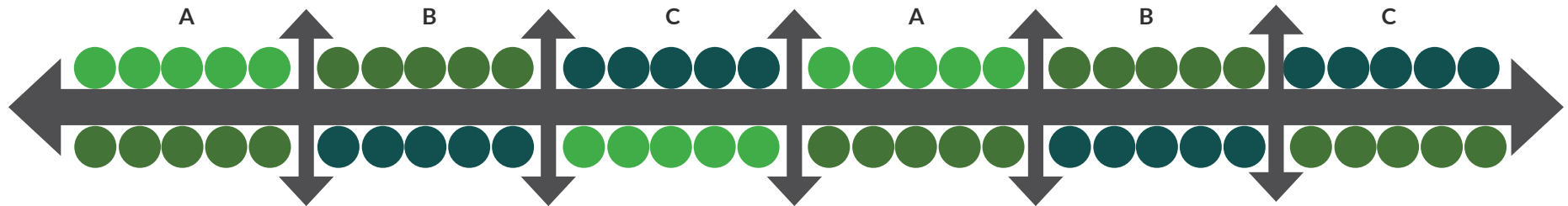

Veirs Mill Road | Georgia Avenue | University Boulevard West

Option A: A mix of large trees that vary by block and are planted approximately 30' on-center. Street tree planting patterns will be determined as part of on-going redevelopment and infrastructure improvement projects.

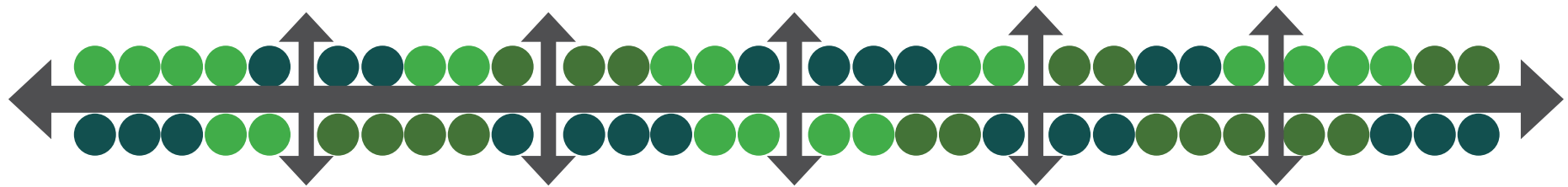

Option B: Include a mix of three large tree species planted approximately 30' on-center. No more than five trees of the same species are planted consecutively.

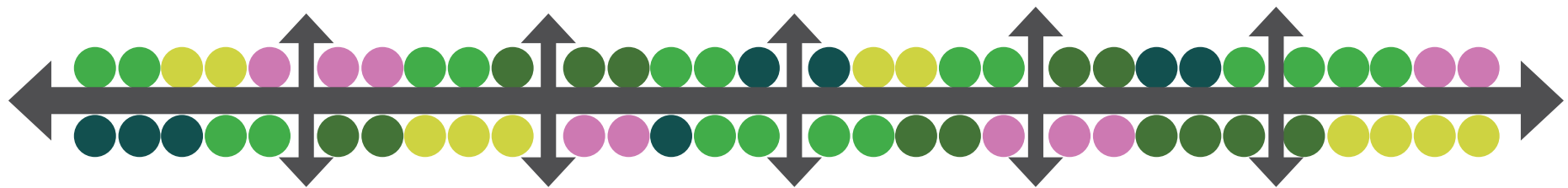

Typical Public Street

Develop a mix of three to five medium-sized tree species planted approximately 30' on-center. No more than five trees of the same species are planted consecutively.

Private Streets

Implement a flexible street tree planting pattern. While the spacing may be irregular, the tree density should achieve as close to 100% tree canopy as possible.



Planter Types

Continuous Planter

A buffer zone with continuous planters creates a separation between the roadway and sidewalk clear zone, providing safety and comfort to pedestrians and maximizing the amount of open soil available to street trees. Continuous planters should be employed wherever possible, especially along streets with higher volumes of pedestrian activity. While continuous planters can be a safety barrier advantageous for pedestrians on streets with high vehicular traffic, in areas with curbside parking, pedestrian routes to parked vehicles must be provided. When constructing continuous planters, allocate curb zone space to accommodate a pedestrian step-off area where curbside parking is present, and provide intermittent paved connections from the curb zone to the clear zone where curbside parking is present – typically spaced at 60 feet on-center. Further, avoid mulched tree beds where possible and employ a variety of ground-cover plantings. Implementing a variety of plant materials is aesthetically pleasing and environmentally beneficial.

Tree Well

Tree wells are individual planting areas that have a minimum width of five feet and range in length from eight to 12 feet. Tree wells allow for streetscape activities and furnishings between street trees, but typically do not provide the minimum soil volume required. If used, additional soil volume can be provided in the form of structural cells or structural soil panels. Achieving adequate soil volume for proper tree health is generally harder to accommodate with tree wells and will require a covered-soil volume approach.

When building tree wells, consider providing a short curb (approximately 4") that delineates the planting zone and protects the tree space/planting bed from pedestrians and other activities associated with urban life. The curb will also reduce maintenance by keeping mulch within planting beds.



Precedent images of curbside planting treatments.



Soil and Soil Volume

Overview

Tree planting areas should be designed to meet and, wherever feasible, exceed minimum soil volume requirements for street trees without infringing on the clear zone. There are several methods for providing soil volume, including providing open soil areas in the form of tree wells or continuous planting strips, adding soil volume underneath pavement that accommodates root growth while supporting the sidewalk above, or a combination.

Open soil areas, in the form of continuous planting strips or tree wells, are generally encouraged when space allows. This method of providing soil volume maximizes the amount of stormwater infiltrated and offers easy access to oxygen for street tree roots.

When open soil areas do not provide the minimum required soil volume for street trees, covered soil in the form of an amended soil panel or structural cells should be used. Covered soil accommodates tree roots' growth while also structurally supporting the pavement above. Covered soil should also be considered where high pedestrian traffic is expected, and sidewalk widths are constrained.

Typical Tree Planting

The typical street tree planting detail consists of a 12-foot long tree well that accommodates a single street tree. The width of the tree well may vary depending on site-specific conditions, but the minimum width is five feet. This approach will likely not meet downtown Wheaton's soil volume requirement (600 cubic feet per tree). Therefore, this planting method should not be used unless existing constraints (such as the presence of utility vaults and other large utilities) do not permit any of the tree planting methods that allow for expanded (typically covered) soil volumes.

Tree Space with Covered Soil Area

For a tree to grow and stay healthy, adequate rooting space is essential. In ideal conditions, with uncompacted soil, the roots of a mature tree can spread to more than twice the width of a tree's canopy. Tree roots gain nutrients from the soil, but roots also need the air and water that occupy the voids between soil particles. In uncompacted soil, these voids are abundant.

In dense areas, where soils are often compacted and covered by pavement, urban trees rarely reach their full growth potential and have a shortened life span. Covered soil areas allow street trees to utilize additional uncompacted soil volume that would otherwise be unavailable while also supporting the sidewalk above, allowing for a healthier tree canopy and a more flexible sidewalk paving surface above.

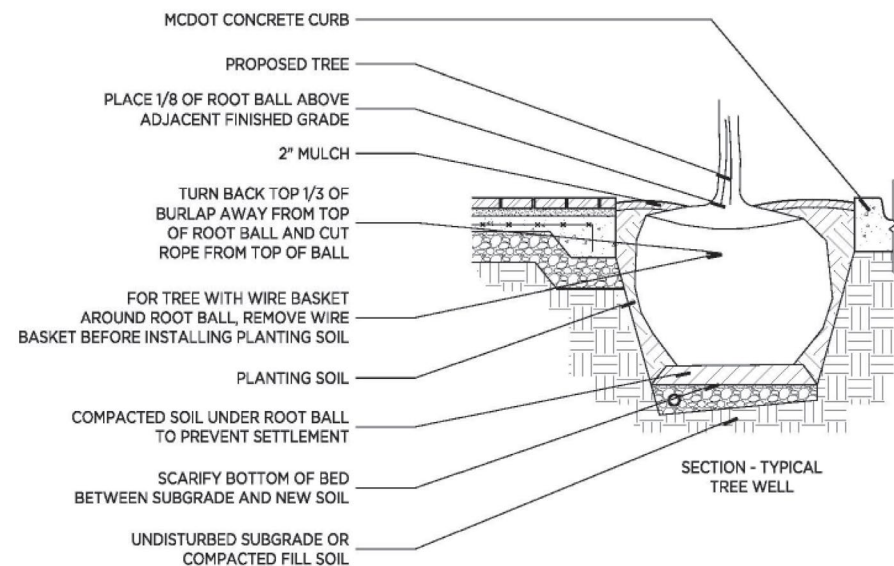

Typical Tree Planting Detail



Methods for Covered Soil

There are two methods of providing covered soil area specified in this document: (1) an amended soil panel and (2) structural cells. These two methods should be applied whenever the open soil volume is less than 600 cubic feet. Regardless, the minimum soil volume for any street tree in downtown Wheaton should be at least 600 cubic feet. Generally, for each square foot of tree canopy spread, there should be at least 1 to 2 cubic feet of soil volume. More significant amounts of soil volume per tree are encouraged; see the table below for recommended soil volume quantities per mature canopy size.

Recommendation	Soil Volume (cf)
Good	600
Better	1,000
Best	1,500+

Recommended Soil Volumes

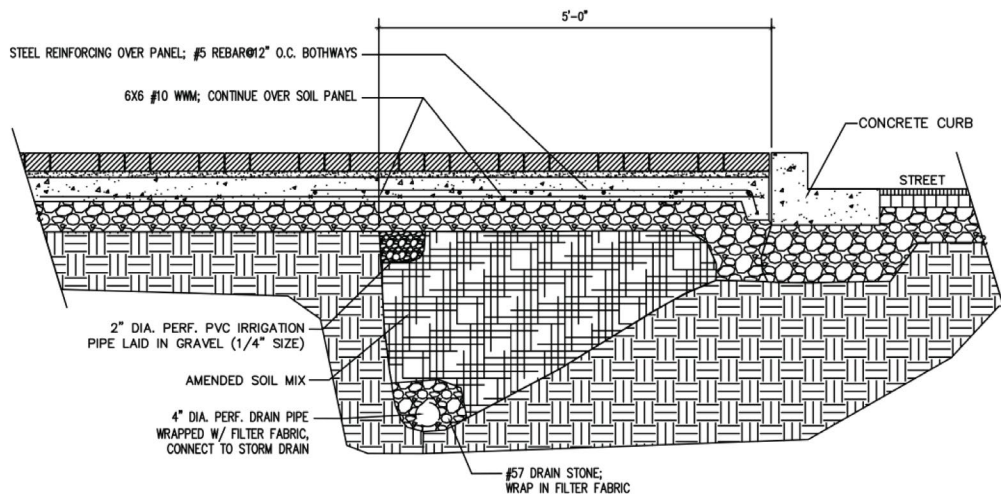

Amended Soil Panel Detail

Amended Soil Panels

An amended soil panel is a tree-planting technique that prevents soil compaction and ensures covered soil remains organic, well-drained, and well-aerated for healthy street tree growth and long-term survival. Its installation allows tree roots to properly extend into adjacent covered soils beneath the pedestrian through zone while directing root growth away from the curb and drive lanes via timber or concrete shoring.

Construction begins with the removal of all existing soil and pavement. The prepared soil mixture containing one-third native soil provides a suitable consistency for the tree in the urban environment. Amended soil panels improve root development by delivering a sub-surface drainage system to carry away excess water, avoiding root rot. Installation of an irrigation pipe will allow for manual watering of several trees at once during drought periods.

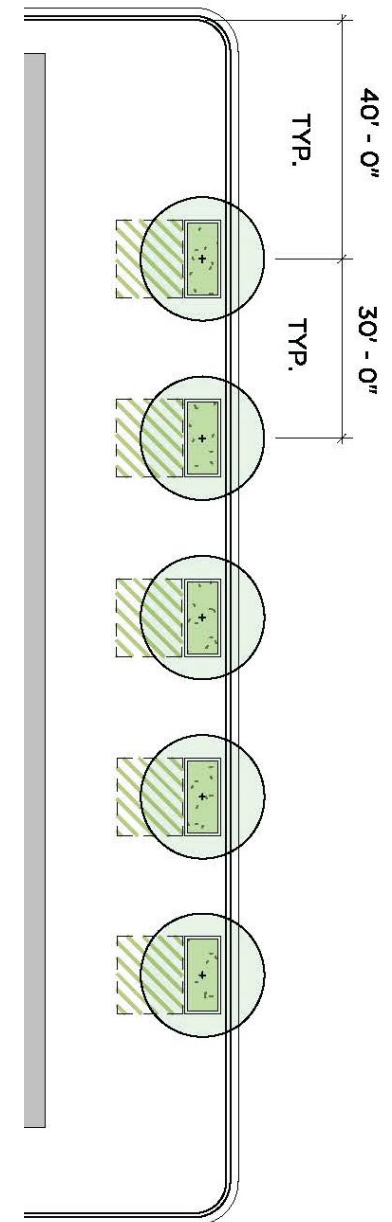

Amended Soil Panel Tree Well Plan



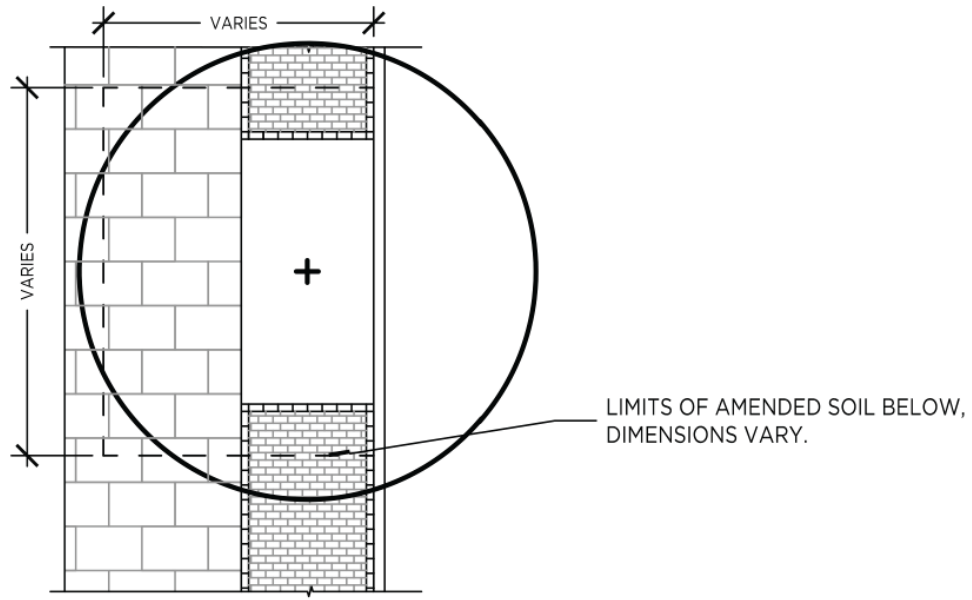
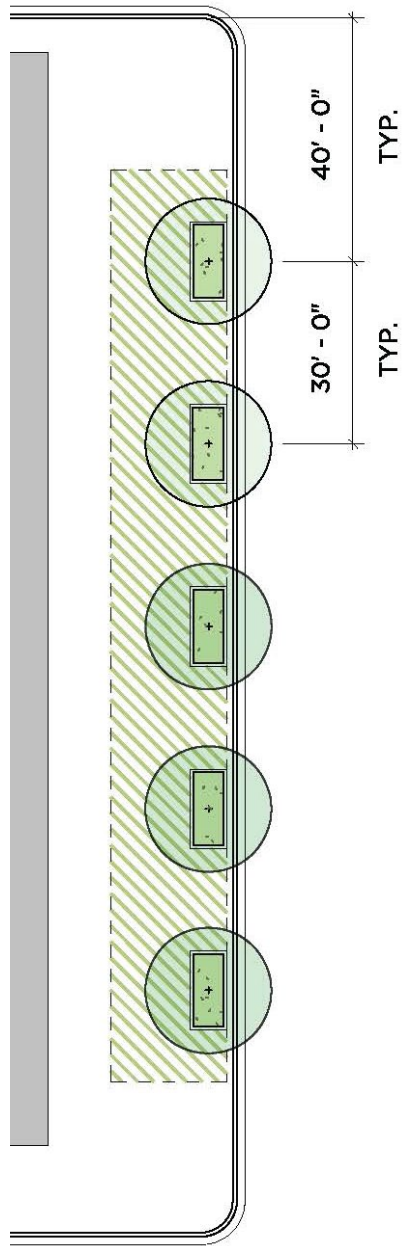

PLAN - TREE PLANTER WITH AMENDED SOIL PANEL

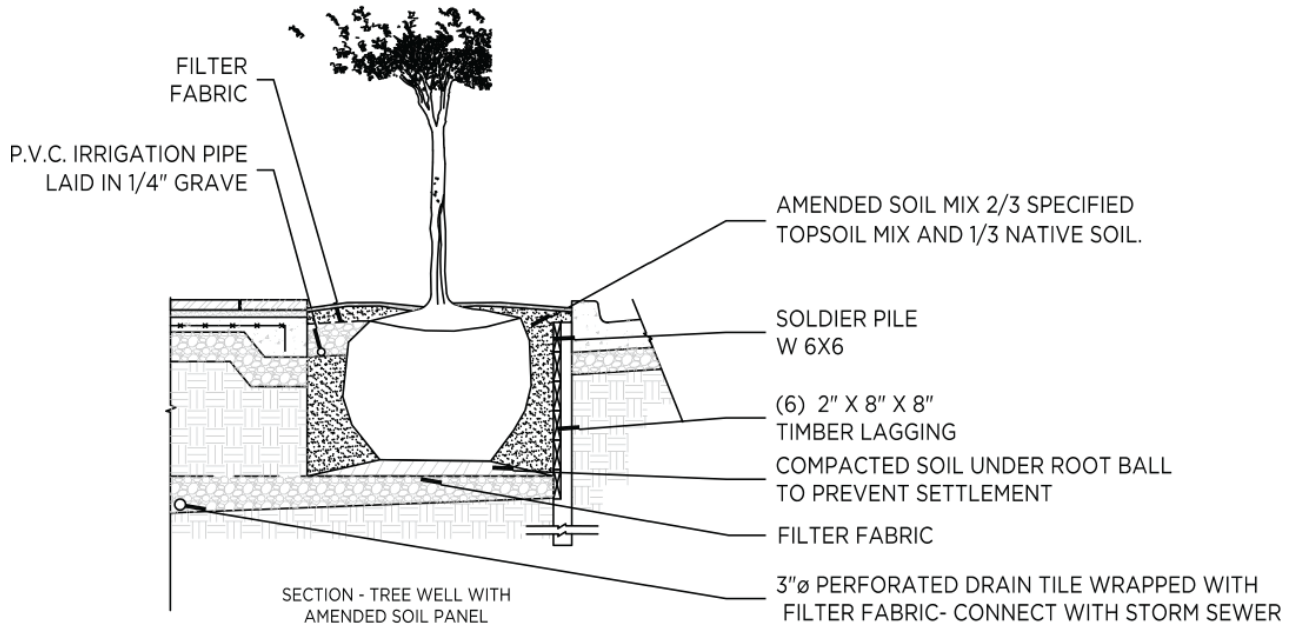

SECTION - TREE WELL WITH AMENDED SOIL PANEL

Methods for Covered Soil: Continuous Planter

General Tree Planting Detail



Structural Cells

Structural cells are manufactured pavement support systems, typically made of plastic or recycled materials configured in a stacked, pillar-like arrangement. The soil between the pillars remains un-compacted to promote tree root growth and soil health. Structural cells are often selected instead of an amended soil panel due to the greater volume of uncompacted soil space created by the cell system. Structural cells also allow for increased stormwater infiltration but are most effective when larger systems are installed and interconnected with other stormwater management best management practices (BMPs).

Structural cells should be employed in areas where an amended soil panel cannot provide the adequate volume needed to meet soil volume requirements. The cells should be located beneath the pavement in the applicable covered soil area and are most cost-effective for street trees along sidewalks with extremely constrained widths (i.e., planting/furnishing zones less than 6 feet wide).

Due to the structural network of these cells, the location of any underground utilities requires coordination for placement and grouping. When installed, underground utilities must be protected from root penetration via root barriers.

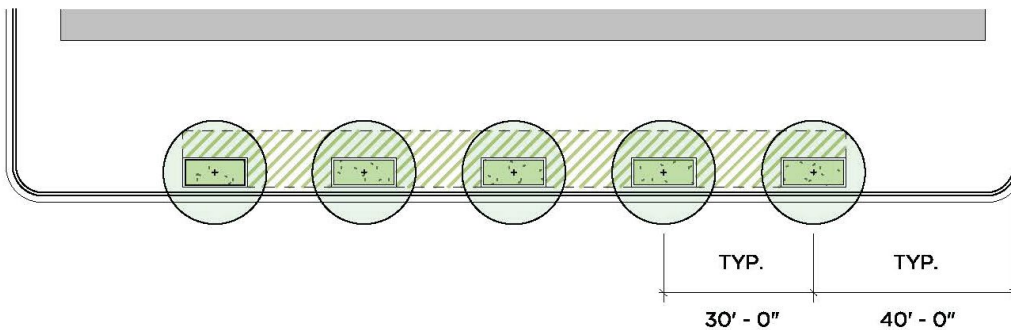

Structural Cell Planter Plan Diagram

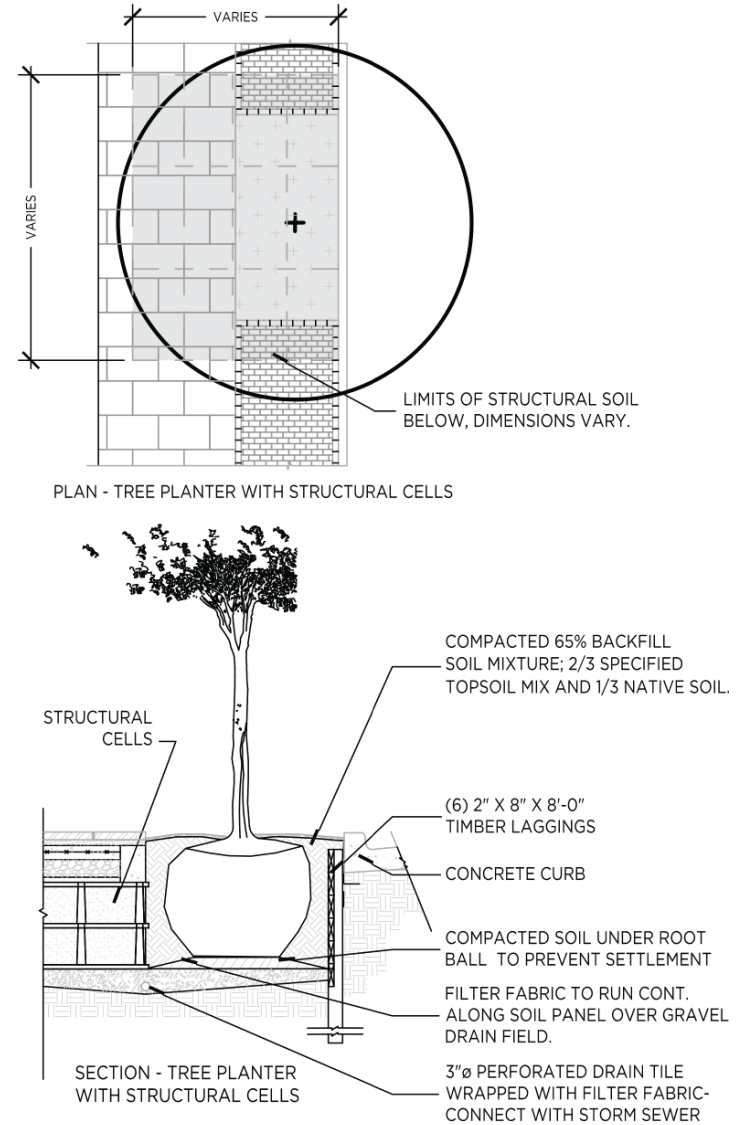

Structural Cell Planter Details



Groundcover Plantings

Overview

Tree Planter and Median Plantings

Planting beds within streetscape environments should create a lush, full effect. Plants must be tolerant of a wide range of soil and moisture conditions and should be selected for foliage and textural contrasts. Plants should also be native, non-invasive, and low-maintenance varieties and species. It is recommended that planting beds include both grasses and shrubs. Perennial flowers may be used instead of or to supplement grasses. Plants should be selected to minimize excessive vegetation removal during seasonal cutback.

Movable Planters

Movable above-ground planters may be located within the streetscape such that they do not block the sidewalk clear zone. They add greenery to the streetscape without permanently eliminating paved space for pedestrians. When space allows, planters work well to protect and buffer pedestrians from moving vehicles and further define the district's sense of place. All planters added to the sidewalk must be regularly maintained and are the responsibility of the organization, property owner, or business owner who installs them.

Movable planters may include annual and perennial flowers to provide visual interest. Plantings should not block pedestrian views or intersection lines of sight. Thorned and heavily littering plants are discouraged for pedestrian safety.

Planted Medians

A median is the portion of the roadway separating opposing directions of the roadway. The design and landscaping of medians should emphasize continuity along corridors.

Landscaping, lighting, and street furnishings should maintain a similar look and feel in medians along the entire length of a corridor. Median trees may include small flowering or medium-sized trees as defined in the County's list of approved street trees. Understory plantings should be native, non-invasive, low maintenance, and not block sight lines.





Clockwise from top left: Precedent images of stormwater management sidewalk installation; movable and hanging planters, and planted medians.



Groundcover Typical Layout



Type 1: Shrub Examples



Compact Inkberry Holly



Compact Winterberry Holly
(Use 1 male to 5 female shrubs)

Understory planting should include vibrant, hearty and colorful plantings. Layering of textures and colors add variety and character to the streetscape.



Type 2: Ornamental Grass Examples



Pennsylvania Sedge



Liriope

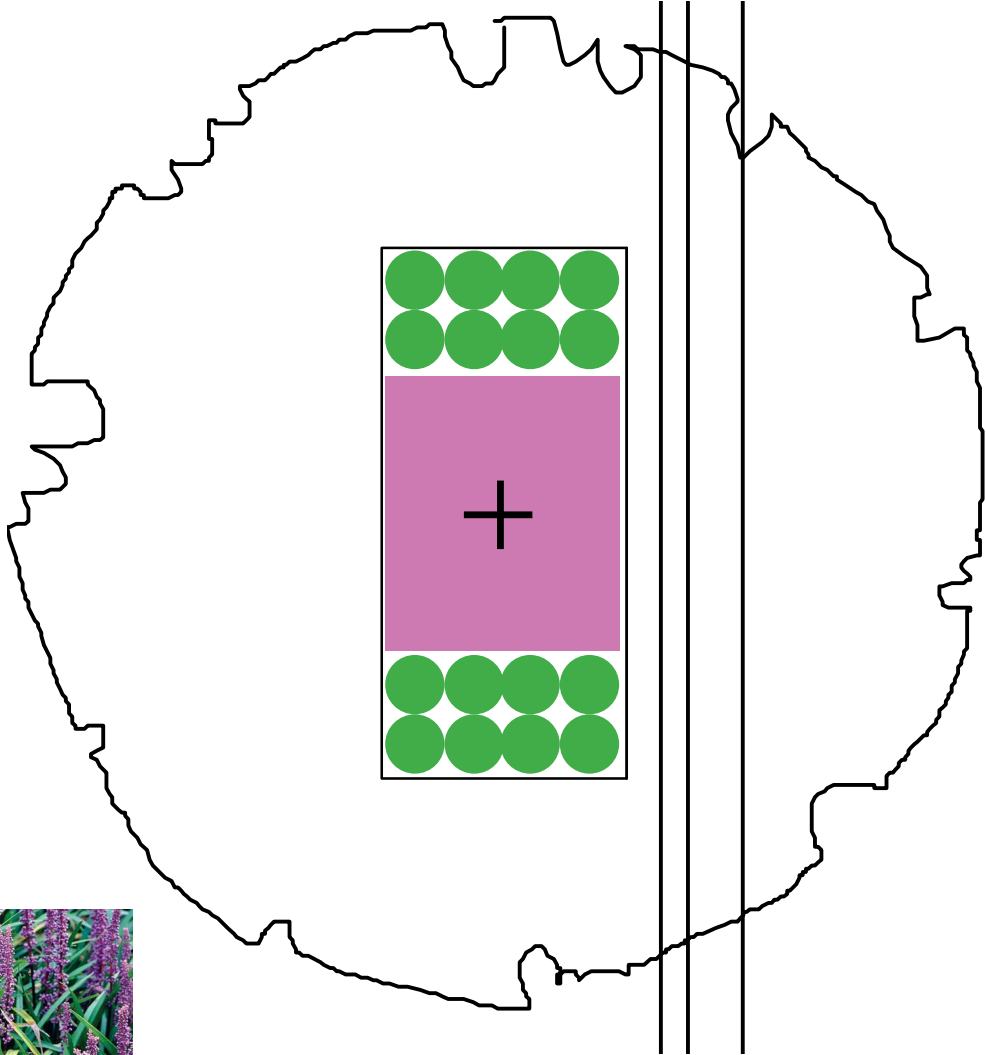

Example of Tree layout



Special Considerations

Typical Planting Strip: Vegetated Stormwater Collector

The vegetated stormwater collector is essentially a tree well engineered to absorb a larger volume of stormwater runoff. Breaks in the curb serve as inlets to allow stormwater into the planter and outlets for excess runoff. Drains connect each vegetated stormwater collector to create an interconnected system. A tree well that acts as a stormwater collector requires a fence between it and the clear zone, a 2-foot flat, paved buffer when next to the curb, and a slope steeper than 3:1. Stormwater management practices must be designed per Maryland Department of the Environment and Montgomery County Department of Permitting Services requirements.

Irrigation

Installation of permanent sidewalk planting irrigation systems is not generally preferred in the public right-of-way (ROW); however, the practice is acceptable if well-maintained and used sustainably. The use of temporary watering bags and/or regular tree watering for at least the first six months after the initial tree planting is strongly encouraged.

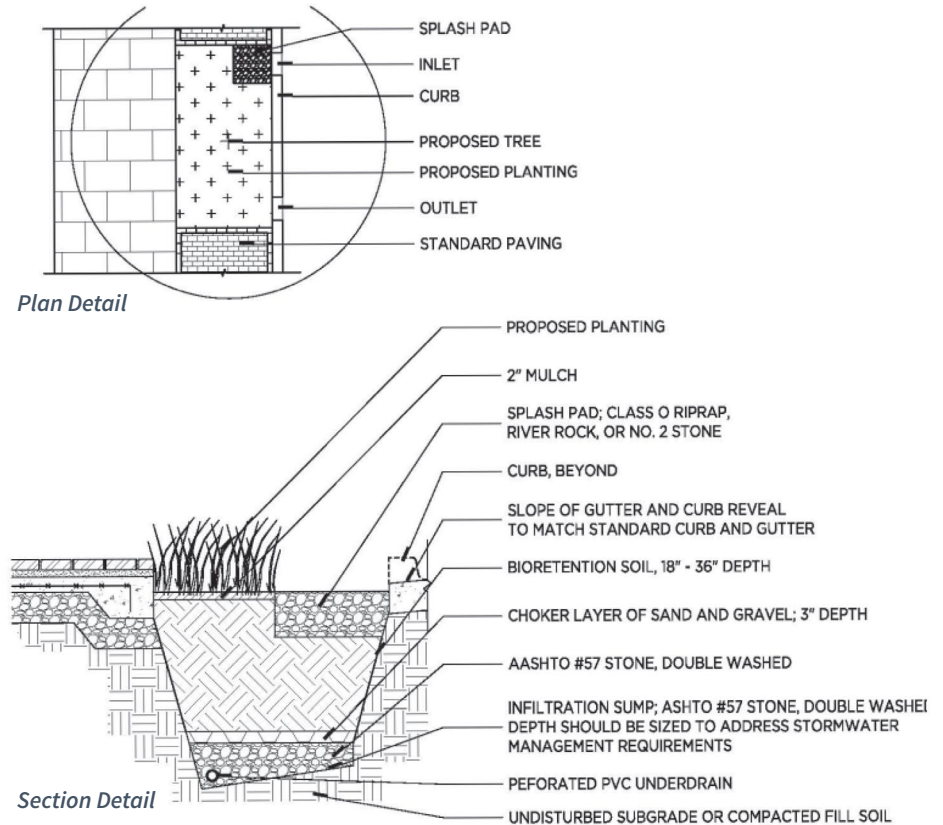

Stormwater Infiltration Planter Details



Examples of Infiltration Planters





CHAPTER 5

Furnishings, Lighting, and Utilities

Street Furnishings

Usable Spaces

Gathering spaces should be created for pedestrians to stop, rest, orient and interact. These spaces could contain benches, plantings, and trash/recycling receptacles. There is great flexibility provided for the selection of site furnishings throughout the area; site furniture should reflect the contemporary architectural forms of the district and should be low maintenance and durable.

Additional criteria for site furnishings include:

- Coordinate color and style furniture elements throughout a project site.
- Select site furnishings that incorporate a high percentage of recycled and/or renewable materials.
- Locate furniture so that it does not impede pedestrian traffic or line of sight at intersections.
- Furnishings such as benches and trash receptacles should be clustered near intersections as a minimum standard. If a block is more than 500 feet in length, an additional cluster of furnishings should be located in or near the mid-block portion of the streetscape.

Fixed Seating

Providing areas for seating along sidewalks is important to make streets inviting for patrons. There are a number of seating types that could be considered including freestanding benches, both backless and with backs, and also seat walls which can become signature features of the district.

- Seating should be affixed in such a way that it is not easily damaged or removed (unless it is movable by design).

- Care should be exercised to ensure that seating does not interfere with entrances to buildings, heavily used loading zones, parked vehicles, fire escape routes, and other potential conflicts.
- Seating should be located to enable pedestrians to view street/sidewalk activity while being outside of the immediate flow of pedestrian traffic.
- Public seating should be buffered from noise and vehicle exhaust where feasible.
- Seating at bus stops, whether there is a bus shelter or not, should face the street or face approaching buses.



Example of seating areas within the Frontage Zone and Buffer Zone.



Street Furnishings - Continued

Movable Cafe Seating

Cafés may be placed in the frontage zone or the street buffer zone as long as the required clear zone widths are maintained. They may be acceptable in curb extensions as long as they do not inhibit sight lines or accessibility for pedestrians and bicyclists.

- A sidewalk café in the Buffer Zone should not interfere with the loading and unloading of transit vehicles, designated accessible parking, or bicycle operations.
- All sidewalk cafés must comply with Americans with Disabilities Act (ADA) requirements.
- The preferred minimum width for a sidewalk café is 6 feet.
- A sidewalk café must be enclosed in a clearly delineated area with a controlled point of ingress and egress and surrounded by a continuous barrier.

Trash and Recycling Receptacles

To ensure the Pedestrian Zone is maintained, receptacles for trash and recycling should be placed in the Street Buffer Zone. Where a Street Buffer Zone is not present, placement of receptacles should ensure that a minimum 5-foot clear zone for pedestrians is maintained.

- Consider placing trash receptacles near high-pedestrian volume locations.

Bicycles

The standard bicycle rack is an inverted-U rack/staple.

- Bicycle parking facilities shall not obstruct pedestrian traffic or interfere with the use of the pedestrian area. Bicycle racks should be installed in convenient, well-lit areas where people on the sidewalk or visiting a nearby building can see them.

Planting Containers

The use of planting containers are encouraged in the streetscape environment. Ideally, planting containers should be located near building entrances, seating areas and to add color and vibrancy to street intersections.



Example of street furnishings within the Buffer Zone (benches, bicycle racks, trash and recycle receptacles)



Lighting

Light Fixtures

Continue to utilize the Wheaton Decorative LED Optics Vehicular Luminaire along downtown Wheaton's three boulevards: University Boulevard West, Georgia Avenue, and Veirs Mill Road. Corridors should include both vehicular and pedestrian scale lighting. Continue to use the Wheaton Decorative LED Pedestrian Luminaire along all other public streets.

- All lighting should conform to the standards of the Montgomery County Department of Transportation and the Montgomery County Zoning Ordinance.
- Lighting along privately managed streets may vary from the Decorative LED Pedestrian Luminaire. When selecting luminaire alternatives, consider all street users, including people driving, walking, biking, and accessing or waiting for transit. Alternatives should conform to Montgomery County Department of Transportation and Montgomery County Zoning Ordinance standards.
- Locate lighting in the Street Buffer Zone, oriented towards both the roadway and the sidewalk. Ensure adequate illumination at intersections and pedestrian crossings. Access ramps, crosswalks, transit stops, and seating areas that are used at night must be visible and lit.
- Alternate the placement of streetlights and trees so that trees do not block the illumination.
- Combine Pedestrian and Vehicular luminaires in high activity areas to encourage pedestrian activity at night.
- Locate pedestrian lighting on the same pole as roadway lighting to reduce the number of poles along the street.



Wheaton Decorative LED Pedestrian Luminaire

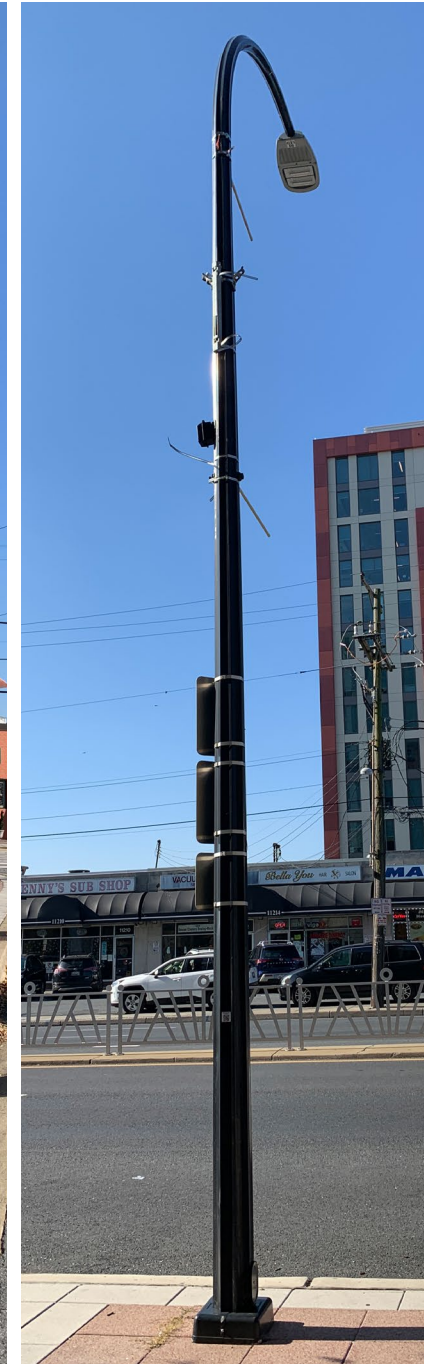

Wheaton Decorative LED Optics Vehicular Luminaire



Utilities

Overview

Utilities are an essential part of the urban environment. When they are well-coordinated they can contribute to a cohesive, orderly, and more beautiful streetscape. Whether a project is a new development, a renovation, or repair job, utilities should be carefully considered and coordinated with other design elements early in the project.

Streetscape utilities typically include water valves and meters, gas valves, utility laterals and conduits (sewer, gas, water, telecommunications), and utility vaults. Above-ground utilities and furnishings, such as street lights, fire hydrants, signs, traffic light control boxes and parking meters, should also be considered in conjunction with below-grade utilities. The benefits of thoughtful utility placement in the streetscape include:

- A safer environment for users of all abilities traveling through the pedestrian through zone.
- Increased soil volume for street trees because of minimized conflict between utilities and street trees.
- A more unified and orderly streetscape aesthetic.
- Ease of access to utilities and fewer long-term maintenance conflicts for utility providers.

Challenges to utility coordination and placement remain. They include:

- Utility providers that adhere to internal standards for utility placement in lieu of coordinating with the development team.
- The high cost of relocating existing utilities might be financially unfeasible for both new developments with existing utilities on site and for retrofits.

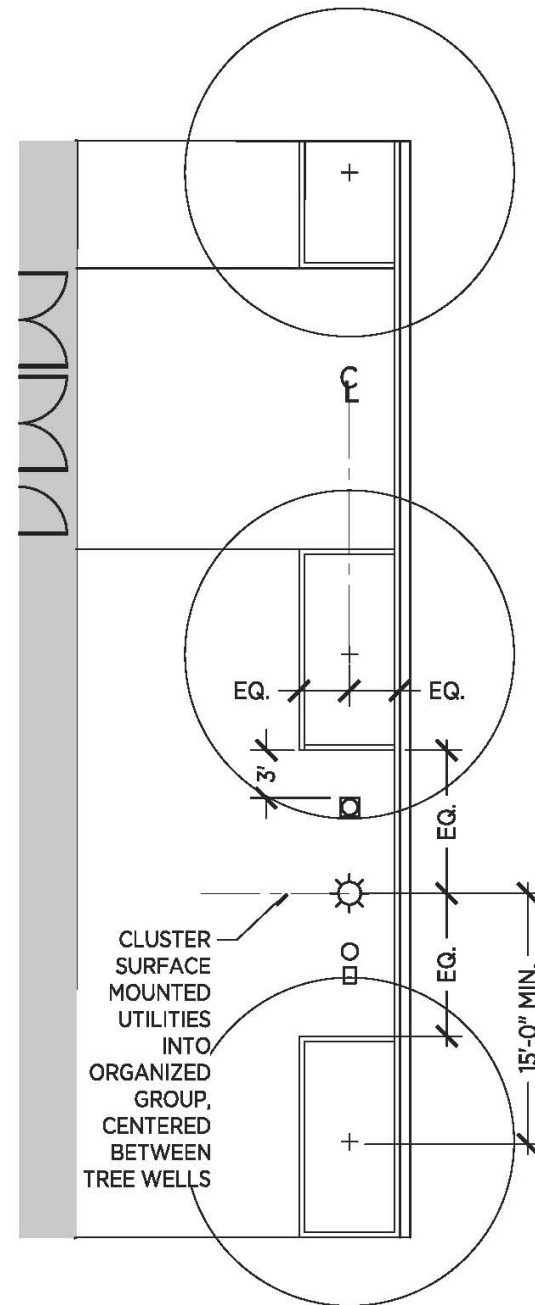

Figure 12: Utility clustering diagram within the Buffer Zone.



Guidelines for Utility Location

Undergrounding of Utilities

All new development projects in downtown Wheaton are expected to place utilities to and around their properties underground.

Timing and Coordination

Utilities should be installed during full or partial sidewalk improvements, rather than a separate, utility-focused project whenever possible.

Utilities should be considered at the earliest possible stage of design. Utility plans should be submitted with the initial development application so that utilities can be located and coordinated to minimize conflicts with other streetscape elements.

Utility Location and Consolidation

Utility lines should be located to minimize disturbance of the existing streetscape elements. In no circumstance should utilities of any kind diminish the accessibility of the clear zone. Utilities that run parallel to the street should be located outside of the planting/furnishing zone, where feasible. Utilities that run perpendicular to the street should be grouped together to minimize conflict with street trees or other BMPs/ESDs. Dry utility conduits and laterals should be aligned, arranged or stacked to minimize the extent of utility zones. Above-ground streetscape utilities, such as streetlights, fire hydrants, signs, and parking meters, should be located at the midpoint between street trees within the planting/furnishing zone.

Utility Vaults

Where feasible, utility vaults should be located on private property. If a vault can only be placed in the public ROW, it is best located in the clear zone to minimize conflicts with street trees or other ESDs in the planting/furnishing zone. Vaults located in the clear zone should have a solid cover flush with the adjacent sidewalk surface and should match the adjacent paving material. Vaults must be constructed in compliance with the Americans with Disabilities Act standards for walking surfaces within an accessible route. A minimum 6-foot wide continuous free and clear path must be provided during maintenance work.

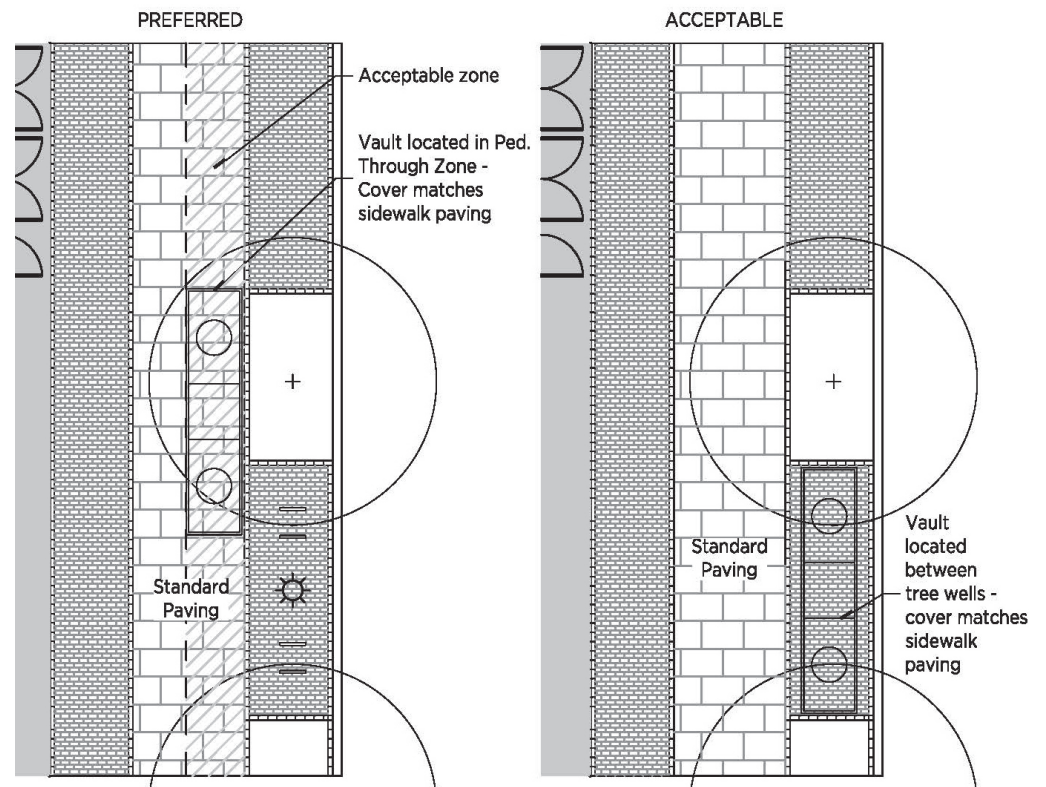

Figure 13: Potential Locations for sidewalk utility vaults.



Mobility Elements

Bus Stops

Bus shelters shall include Montgomery County standard facilities and the placement shall be coordinated with the requirements of the Washington Metropolitan Area Transit Authority (WMATA).

- The location of transit shelters should minimize obstruction of sight lines and should be near protected crossings for pedestrians.
- Shelters should be located to facilitate maintenance (e.g., glass and other elements of the shelter should be easy to replace as necessary).
- Shelters should provide their own light source. Where lighting is not provided in the shelter, shelters should be located where street lighting is abundant.
- Consider needs for passenger amenities such as additional seating, local area information, wayfinding, real-time traveler information, and heating or cooling capabilities at bus stops.



MCDOT Ride On Extra Bus Stop

Bikeshare Station Placement

Bikeshare stations can vary in size and configuration. Montgomery County's bicycle stations typically provide 15 bicycle docking spaces, with a standard footprint of about 6 feet by 45 feet. Higher capacity stations with a larger footprint are appropriate for locations that generate a significant number of trips. Station locations should:

- Not infringe on the sidewalk clear zone.
- Receive enough sunlight for solar apparatus.
- Provide at least 6 feet of clearance from the back of a docked bicycle to provide room for pedestrian movement.
- Be placed at least 18 inches from the curb where on-street parking is present in order to allow access to vehicles.
- Be at least 2 feet from curb cuts or crosswalks and at least 5 feet from fire hydrants.
- Be placed in visible, well-lit locations, in order to make them easy for users to find, discourage vandalism, and maximize safety for people getting or returning bikes.



Typical Capital Bikeshare Stand



Dockless Mobility

Dockless parking zones should be easy to recognize and demarcated with pavement markings. Sidewalk dockless parking zones should be designed with white corner outlines to demarcate the space, and bike and scooter symbols should be placed within the zone. Optionally, they may also be marked with vertical white lines to designate the preferred orientation of the devices. All markings should be made from durable, slip-resistant paint.

- Locate dockless parking zones in the street buffer zone and ensure that they do not overlap with the clear zone, loading zones, or bus stop loading/landing areas.
- The size of dockless parking zones may vary depending on the anticipated volume of users, but a minimum size of 6 feet by 10 feet is recommended to accommodate at least 10 shared mobility devices.
- Where feasible, dockless parking zones should be co-located with a Capital Bikeshare station to increase the number of transportation options available within one location.



LimeBike Dockless Bicycles





CHAPTER 6

Placemaking Creative Engagement

The 2023 *Wheaton Downtown Study* prioritized strengthening Wheaton's character through revitalizing downtown as an initial step to further the implementation of the sector plan's recommendations. This will require improving connectivity within and beyond the downtown area, enhancing existing public spaces, and creating new public spaces. These improvements, usually delivered incrementally by redevelopment efforts, can be visualized and implemented on an interim basis using tactical urbanist strategies via stakeholder-driven efforts to identify potential improvements followed by cost-effective implementation.

This approach is usually led by a jurisdiction, organization, or resident group to identify desired neighborhood improvements, followed by short-term, low-cost, and scalable interventions to help visualize potential long-term change. As part of a comprehensive effort to improve the public realm in downtown Wheaton this guide includes, as a companion to the 2023 *Wheaton Downtown Study* and streetscape standards, recommendations of locations where such efforts could improve connectivity or access to public use space. These exercises should prioritize:

- **Branding and Wayfinding:** To expand and clarify connectivity between communities and local amenities and services.
- **Expand Publicly Usable Space:** Enhance existing public use space and explore interim locations for additional public use space that support existing businesses and amenities.



Top and Left: Wayfinding Sign, Parklet Example
Bottom: Placemaking Event Example



Connectivity

Opportunities

The 2023 *Wheaton Downtown Study* included several strategies to improve the quality of the public realm and enhance mobility and connectivity among Wheaton's districts. Specific locations for desired improvements are shown on Figure 14. Placemaking events should be conducted for each to identify potential improvements and implement interim strategies. Placemaking events should focus on improving branding and wayfinding as well as enhancing existing and creating new interim public gathering areas.

Branding and Wayfinding

Branding and wayfinding should celebrate the unique character of downtown Wheaton and seek to strengthen and promote the arts. Given the variety and evolution of wayfinding methods, creative and innovative wayfinding and branding solutions are encouraged and will be considered as placemaking efforts get underway.

Expand Publicly Usable Space

Given the limited availability of public use space in downtown Wheaton, enhancing existing spaces and identifying locations for interim public use space is critical. Targeted improvements to Wheaton Veterans Urban Park, as discussed below, provide an opportunity to enhance this existing resource. However, the creation of additional public use space in downtown will remain difficult until further redevelopment opportunities become feasible. Given this, interim public use spaces, in the form of parklets or shared streets should be explored and implemented.



*Top and Left: Parklet Examples
Bottom Right: Pike District Placemaking Event Example*



Pathways

- ① Establish branded pathway along Ennalls Avenue
- ② Redesign Kensington Boulevard to include linear open space and improved streetscape
- ③ Improve Blueridge Avenue to include local street connections, wayfinding, lighting, and landscaping
- ④ Formalize pedestrian paths to connect communities to the Triangle through Wheaton Westfield Mall
- ⑤ Improve pedestrian areas along Georgia Avenue between Reddie Drive and Ennalls Avenue (extended)
- ⑥ Transform Veirs Mill Road to enhance walkability and create public space

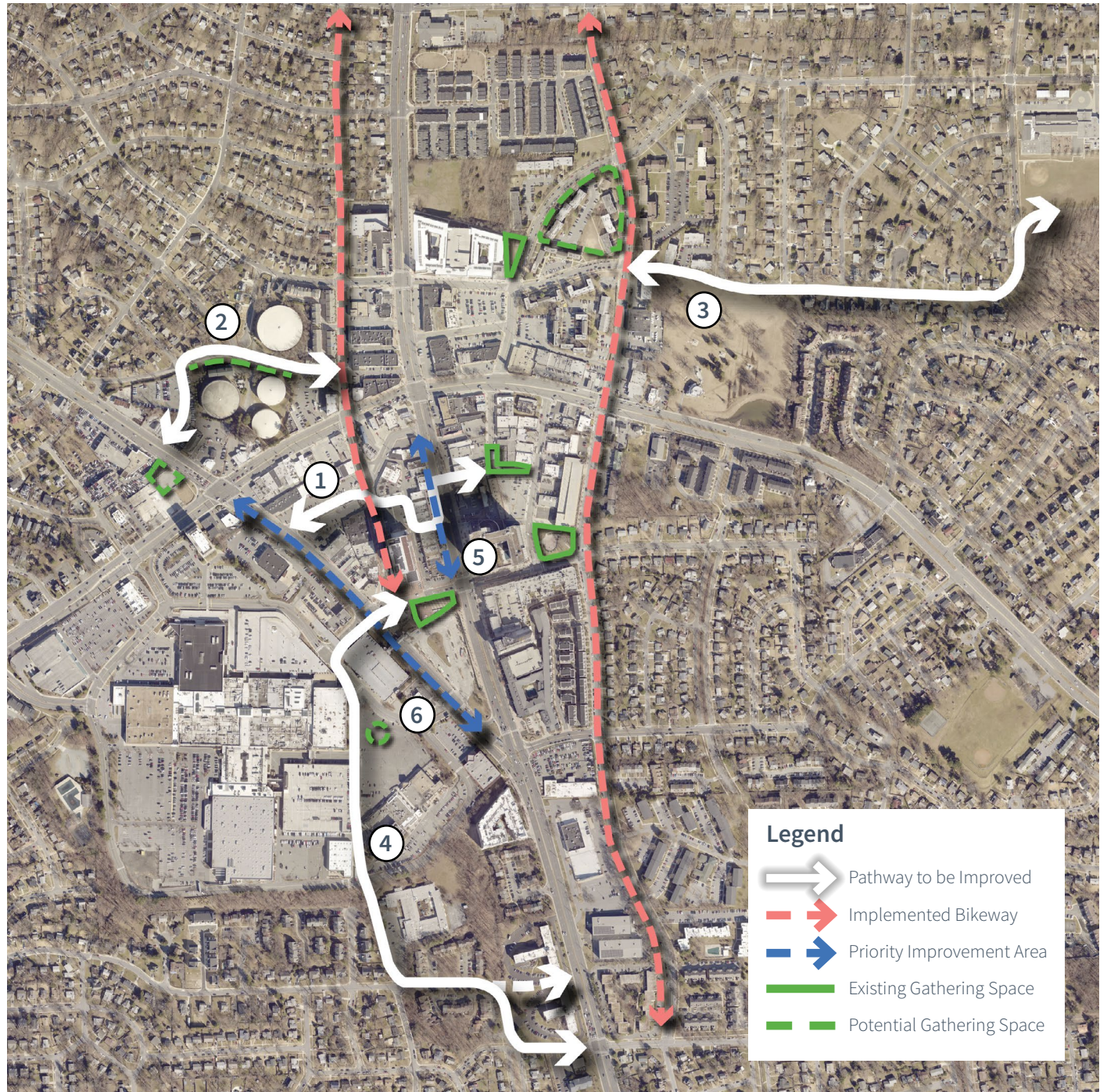

Figure 14: Pedestrian Improvement Areas



Enhance Existing Public Open Space

Wheaton Veterans Urban Park

The only public green space in downtown, has primarily served as a contemplative place honoring those who served in the military. Frequently used for public events, targeted improvements could be explored to enhance its attractiveness as an everyday passive recreation area without detracting from its memorializing purpose.

Potential improvements should not rebuild the park, but enliven it and define activity zones for users. Enhancements could also highlight the area as an entry point to downtown Wheaton from the east.

It is recommended that a qualified landscape designer is engaged to plan and coordinate improvements.

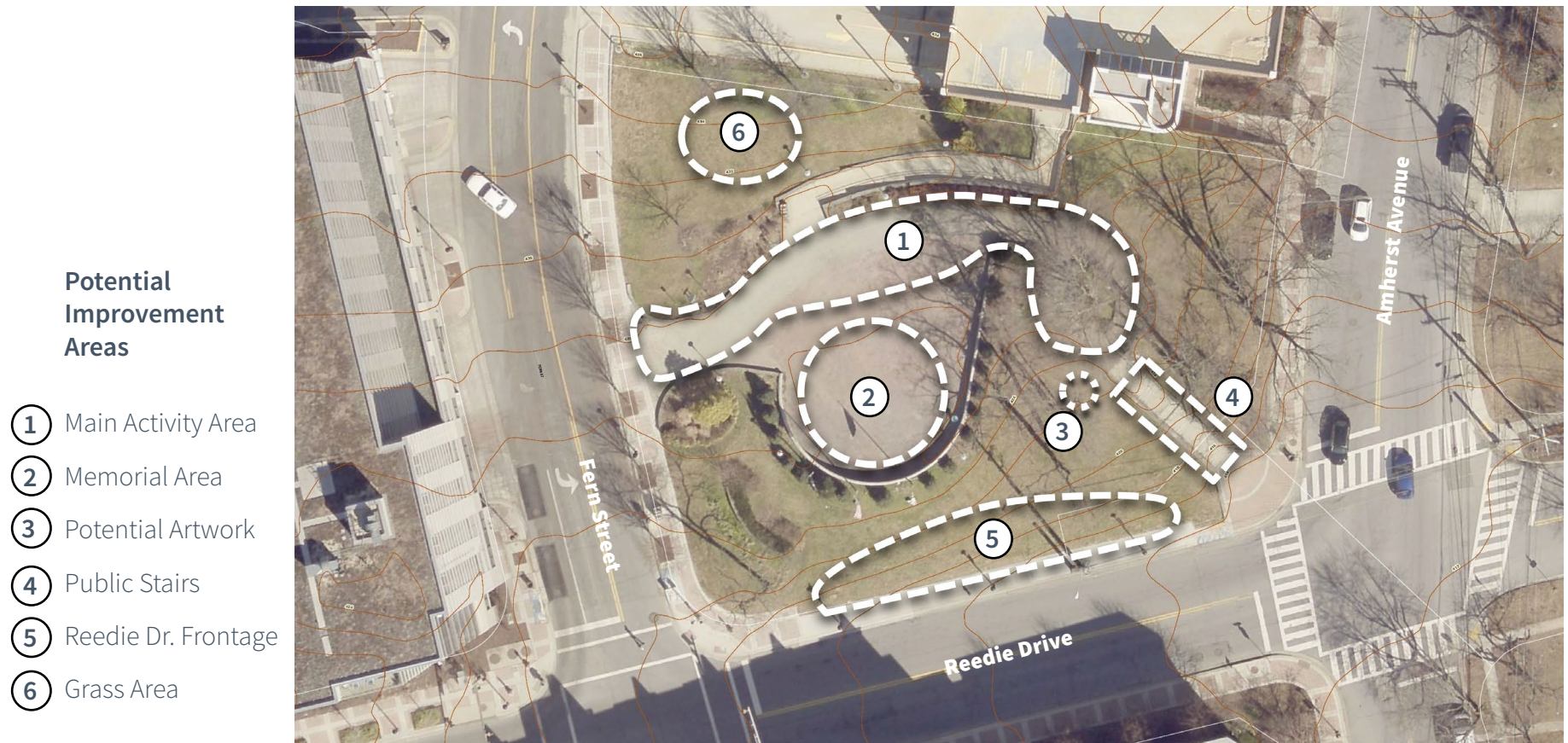

Figure 15: Potential improvement areas within Wheaton Veterans Urban Park.



Improvement Areas

Area 1: Main Activity Area

- Explore painted treatments to define areas for seating or activity while allowing passage through this area.
- Consider seating elements that incorporate planted elements.
- Consider a gateway entrance to the memorial from Fern Street.



Area 2: Memorial Area

- Explore illumination alternatives for the memorial area, to expand use and improve visibility of the memorial from a distance.
- Explore ways to expand secured seating alternatives without detracting from the park's memorial function.



Wheaton Veterans Urban Park - Improvement Areas

Area 3: Potential Artwork

- Consider the addition of a vertical art element near the public stairs to attract interest from Amherst Avenue below, and to highlight a path to the memorial.
- Explore themes and colors reflective of the community's diversity and supportive of the park's memorial function.

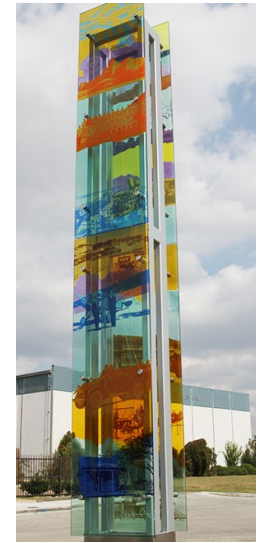
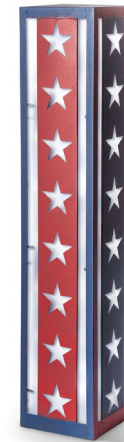

Area 4: Public Stairs

- Stairs are currently used as a waiting area for parents and their children waiting for school buses.
- Consider engaging local arts groups to explore installations to add color and interest to the stairs.
- Explore locations to add fixed seating for school bus user.

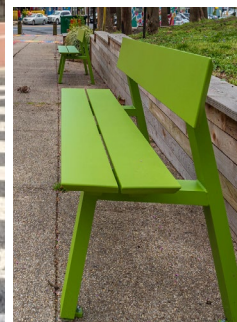
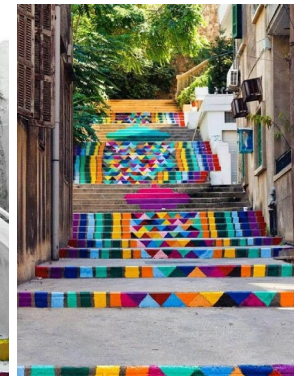
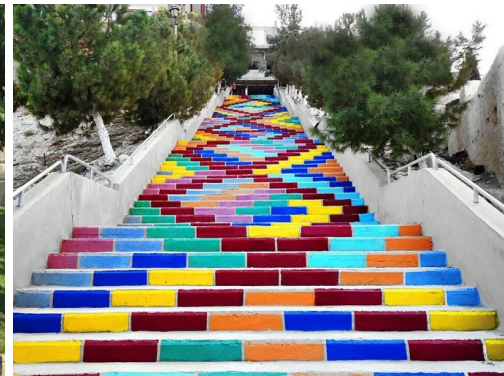

Area 5: Reddie Drive Frontage

- Explore terracing the Park's edge along the sidewalk to provide fixed seating outside from the sidewalk area.
- Consider integrating additional plantings along the terraced areas.

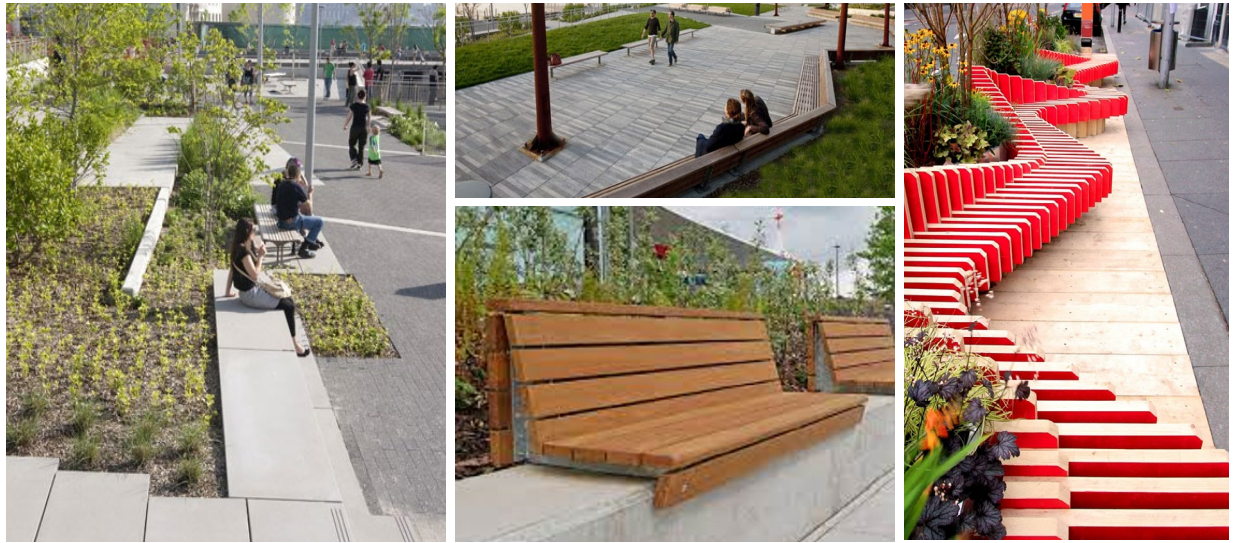

Area 6: North Grass Areas

- Explore creating areas for soft play.
- Provide secured seating. Where seating is provided, include shading alternatives (either shading elements of landscape) to encourage use.



Interim Gathering Space

Parklets

Parklets convert existing on-street parking, travel lanes, or alleys into usable public gathering space. Interventions like parklets can temporarily convert narrow sidewalks into comfortable sidewalks, or transform on-street parking or travel lanes to areas for outdoor dining. These interim streetscapes have been applied nationally with proven success, especially along sidewalks and streets with adjoining ground floor retail and restaurants. Parklets can provide places for people to linger, dine, play and gather without obstructing the pedestrian through zone.

As parklet locations are explored, full cooperation and approval of immediately adjacent businesses is strongly encouraged.



Parklet Example

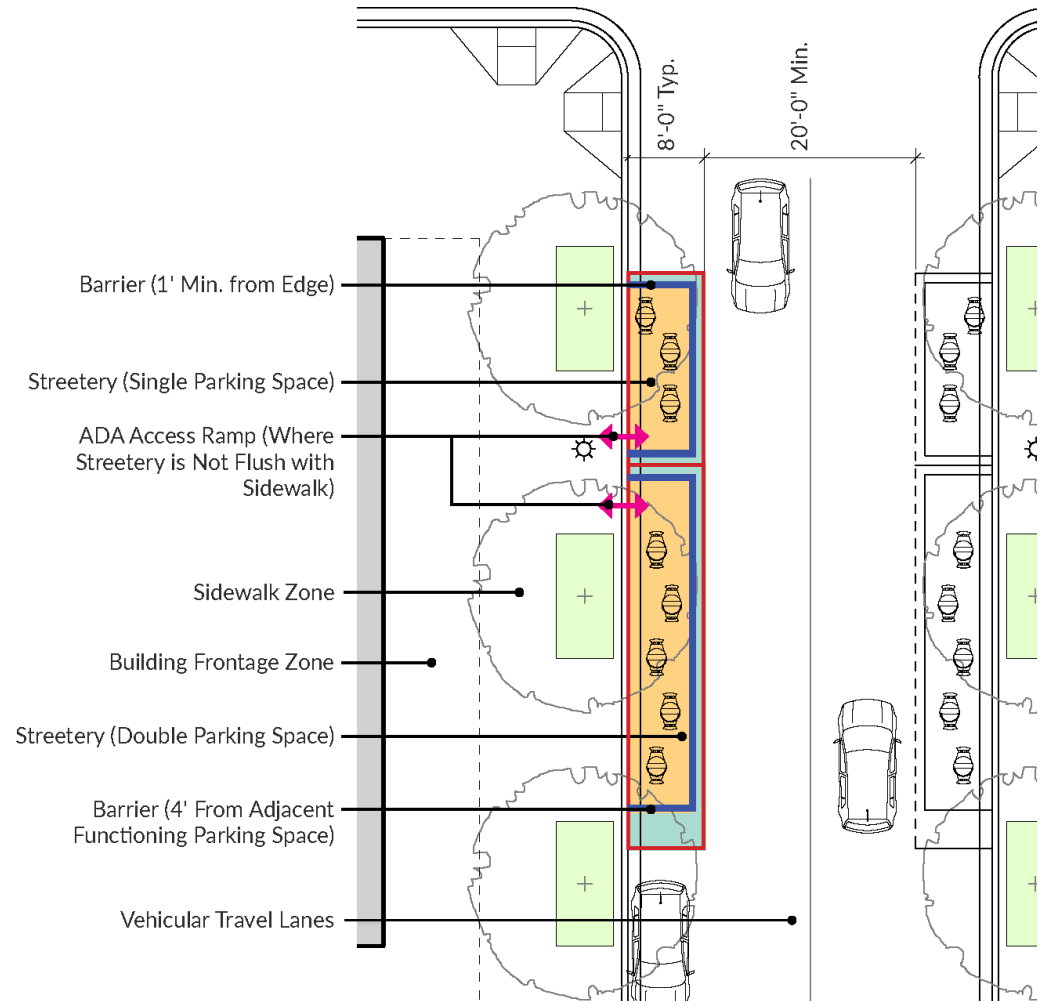

Figure 16: Parklet diagram on existing two-lane street



Shared Streets

If interim parklets are deemed successful over time, consideration should be given to a more permanent project. Working with confronting businesses, a parklet could be converted to a shared street. A shared street would permanently redesign the street as a pedestrian priority environment for public gathering. Figure 17 illustrates an example of such an installation following the streetscape standards and materials recommended in this update. A qualified design professional must be engaged to explore the implementation of such an alternative.



Shared Street Example

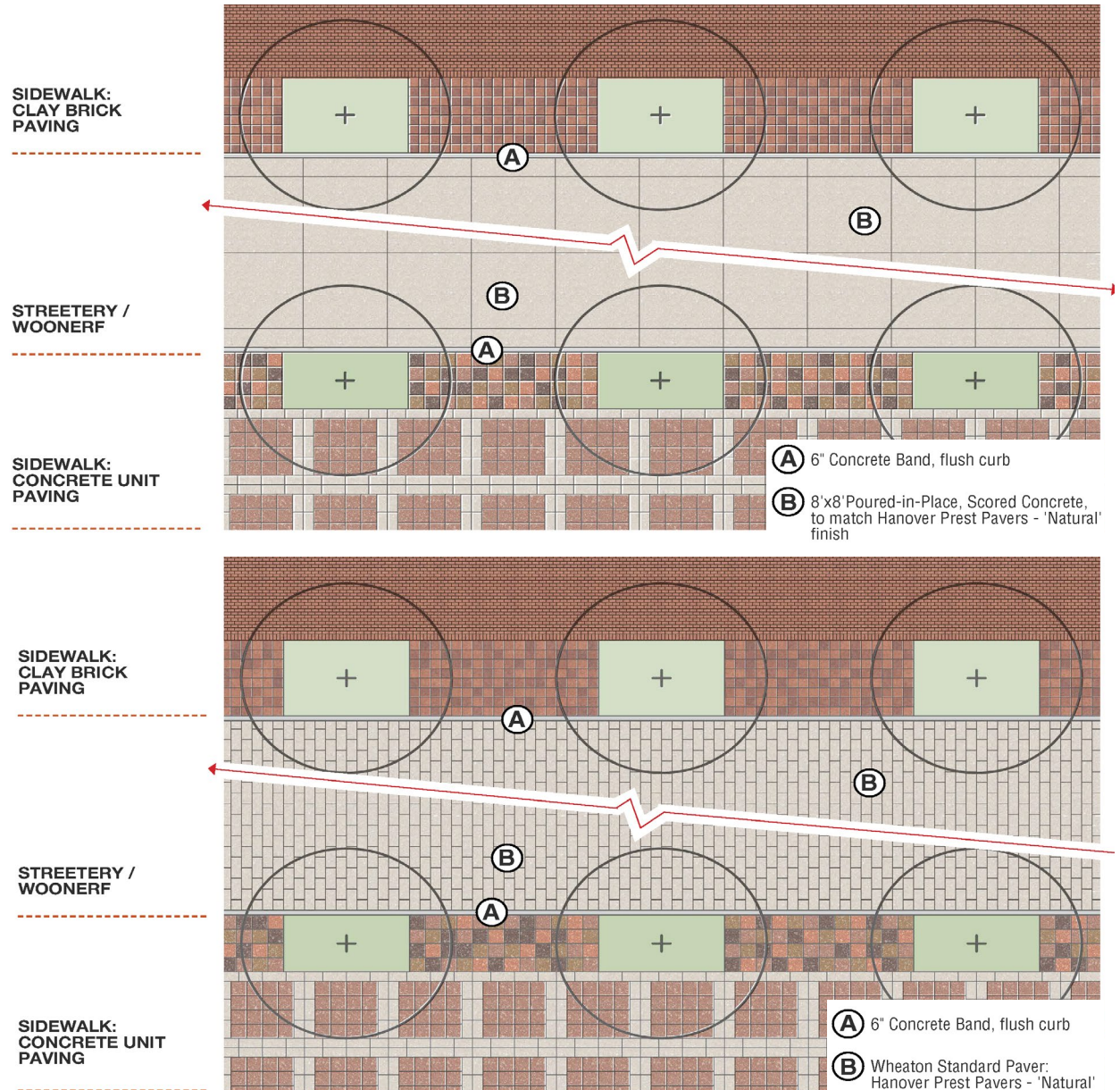

Figure 17: Alternatives for full shared street pavement



Conclusion

The original Wheaton Streetscape Standards were developed at a time with less complex requirements for delivering a safe and attractive pedestrian environment. Not enough development has come to downtown Wheaton in the last twenty years, but much effort has been invested in improving the quality of the public realm through the incremental implementation of streetscape improvements, which absent significant redevelopment have become a defining visual for the downtown area.

The updated Wheaton Streetscape Standards address downtown's present and future needs by incorporating recommendations from recent planning initiatives to expand access to transportation alternatives, improve safety for all users, promote sustainability, and ensure comfortable access for those with mobility challenges. To continue to reflect the diversity and character of the area, the Streetscape Standards also seek to maintain the visual legacy established by the recognizable Wheaton sidewalk pattern, which combined with a complete streets approach can continue to be implemented, along with other alternatives recommended, and offer safe access to all residents and visitors.





NO STOPPING
8AM-5PM
EX. SUN
NO STOPPING
ANY TIME

Bethesda
Metro 0.3

NO STOPPING
ANY TIME

BETHESDA ROW





Wheaton

STREETSCAPE STANDARDS



301 495 4610



www.MontgomeryPlanning.org



2425 Reedie Drive, Wheaton, MD 20902

 **Montgomery Planning**

